

BAHCO®

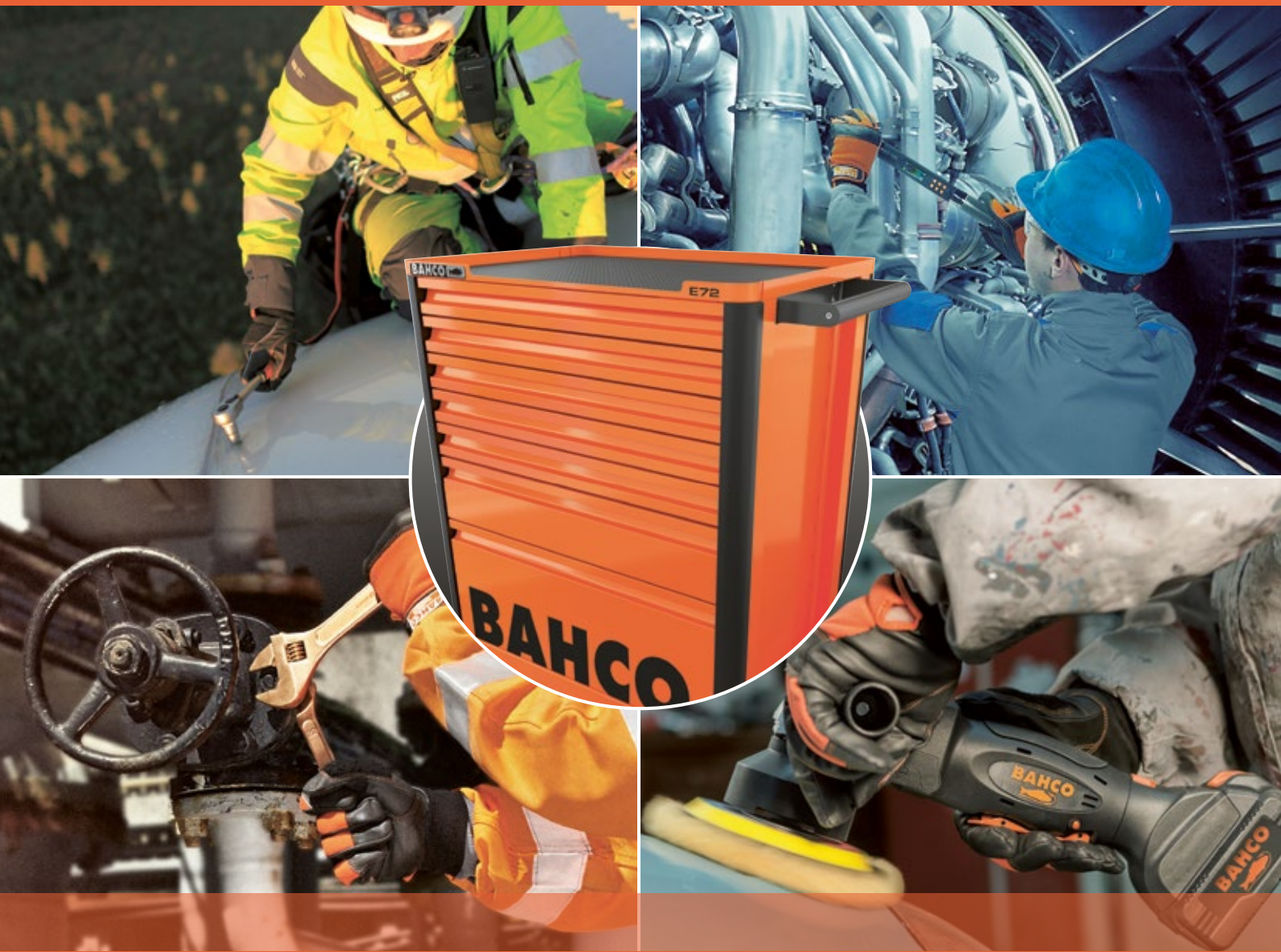

INDUSTRIE

Wir geben Profis, was sie brauchen



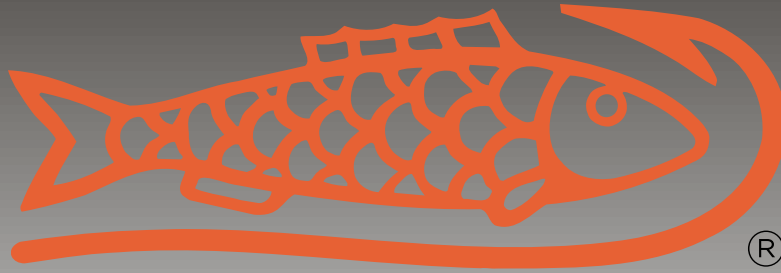

BAHCO

SNA Europe, eine Tochtergesellschaft der Snap-on Inc., ist einer der führenden Hersteller von Handwerkzeugen und Werkzeugen für die Metallzerspanung. Die Produkte werden unter den Marken Bahco, Lindström und Irimo weltweit über Handelspartner vermarktet.

Seit der Herstellung unserer ersten Handwerkzeuge im Jahr 1850 in Schweden entwickeln und produzieren wir in eigenen überwiegend europäischen Produktionsstätten Werkzeuge für den Profi. Unsere Werkzeuge zeichnen sich durch hohe Produktqualität sowie ergonomisches Design für Produktivität, hohen Komfort und Sicherheit am Arbeitsplatz aus.

Heute bieten wir mit über 15.000 Produkten ein breites Sortiment für Anwender in den Bereichen Industrie, Luftfahrt, Automobil & Nutzfahrzeuge, Handwerk, Garten- & Landschaftsbau sowie Obst- & Weinbau.

WIR GEBEN PROFIS, WAS SIE BRAUCHEN

In der aktuellen Ausgabe der Industriekampagne präsentiert Bahco einen Ausschnitt aus dem umfassenden Produktsortiment an sicheren, hochwertigen und ergonomisch ausgereiften Werkzeugen: Topseller, Neuheiten, Werkstattwagen und Werkstattausrüstung. Professionelle Werkzeuglösungen für die Industrie.

Inhalt	Seite	Inhalt	Seite
Fit & Go Werkzeugmodule.....	4–7	Schraubenschlüssel	52–57
Werkstattwagen.....	8–15	Zangen und Seitenschneider	58–61
Edelstahlwerkzeuge	16–19	Druckluftwerkzeuge.....	62–63
Werkzeuge mit Absturzsicherung.....	20–23	Bandsägen	64
Funkenfreie Werkzeuge	24–25	Feilen und Raspeln.....	65
Isolierte Werkzeuge	26–29	Lochsägen.....	66
Drehmomentwerkzeuge	30–33	Metallsägen	67
Akkuwerkzeuge	34–37	Werkzeugkoffer	68–69
Bitsätze und Schraubendreher.....	38–43	Werkzeugtaschen	70–71
Knarren und Steckschlüssel-Einsätze.....	44–45	Automotive	72
Steckschlüssel-Sätze.....	46–51	Lampen, Inspektion	73

Alle Angaben und Abbildungen in dieser Broschüre freibleibend und ohne Gewähr. Änderungen jederzeit vorbehalten. Alle Preise verstehen sich als unverbindliche Preisempfehlung zuzüglich der gesetzlichen Mehrwertsteuer. Gültig bis 31.12.2020 und solange Vorrat reicht.



1/3 FIT & GO MODULE

FF1E1002

Phillips ERGO™ Schraubendreher



39,00 €

BE-8030	0.6x3.5x75	
BE-8040	0.8x4.0x100	
BE-8242	1.0x5.5x150	
BE-8255	1.2x6.5x150	
BE-8257	1.6x8.0x175	
BE-8611	PH1x75	
BE-8621	PH2x100	

FF1E1009

TORX® ERGO™ Schraubendreher



32,50 €

BE-8908	T8 x75	
BE-8910	T10 x75	
BE-8915	T15 x100	
BE-8920	T20 x100	
BE-8925	T25 x125	
BE-8930	T30 x150	

FF1E1010

Isolierte Schlitz und Phillips ERGO™ Schraubendreher



33,80 €

BE-8010S	1,000 V	0.4x2.5x75	
BE-8230S	1,000 V	0.6x3.5x100	
BE-8050S	1,000 V	1.0x5.5x125	
BE-8255S	1,000 V	1.2x6.5x150	
BE-8610S	1,000 V	PH1 x75	
BE-8620S	1,000 V	PH2 x100	

FF1E2001

1/4" Steckschlüsselsatz



101,40 €

6700SM	1/4"	4-5-5.5-6-7-8-9-10-11-12-13-14 mm	
6700TORX-E	1/4"	E4-E5-E6-E7-E8-E10	
6709M	1/4"	3-4-5-6-8 mm	
6709TORX	1/4"	T8-T9-T10-T15-T20-T25-T27-T30-T40	
6950SL	1/4"	1/4" - 120 mm	
6954	1/4"	1/4" - 115 mm	
6956	1/4"	1/4" - 150 mm	
6960	1/4"	1/4" - 50 mm	
6966	1/4"	1/4" - 35 mm	

FF1E2201

1/2" Steckschlüsselsatz



162,50 €

7800SM	1/2"	10-11-12-13-14-15-17-18-19-20-21-22-24-27 mm	
7805SM	1/2"	16-21 mm	
8150SL	1/2"	1/2" - 265 mm	
8160-1/2	1/2"	1/2" - 125 mm	
8162-1/2	1/2"	1/2" - 250 mm	
8166-1/2	1/2"	1/2" - 72 mm	
8165-1/2	1/2"	3/8" - 37 mm	

FF1E2204

1/2" Steckschlüsselsatz

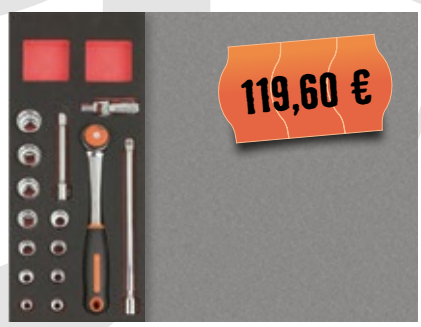

119,60 €

1RM	8-9-10-11-12-13-14-15-16-17 mm	
-----	--------------------------------	--

7800DZ	1/2"	3/8; 7/16; 1/2; 9/16; 19/32; 5/8; 11/16; 3/4; 13/16; 7/8; 15/16	
8150RN-1/2	1/2"	1/2" - 267 mm	
8160-1/2	1/2"	1/2" - 125 mm	
8162-1/2	1/2"	1/2" - 250 mm	
8166-1/2	1/2"	1/2" - 72 mm	

FF1E2203

1/2" Steckschlüsselsatz



154,70 €

7800SM	1/2"	8-9-10-11-12-13-15-16-17-18-19-20-21-22-24-27-30-32 mm	
8150RN-1/2	1/2"	1/2" - 267 mm	
8160-1/2	1/2"	1/2" - 125 mm	
8162-1/2	1/2"	1/2" - 250 mm	
8166-1/2	1/2"	1/2" - 72 mm	

FF1E2209

1/2" Schraubendreher-Einsätze



110,50 €

7809M	1/2"	5-6-7-8-10-12-14-17 mm	
7809TORX	1/2"	T25-T27-T30-T40-T45-T50-T55-T60	
7809XZN	1/2"	6-8-10-12 mm	

FF1E3004

Ring-Maulschlüssel



98,80 €

1RM	8-9-10-11-12-13-14-15-16-17 mm	
-----	--------------------------------	--

1/3 MODULE

FF1E4001

Zangen



84,50 €

1/3 2/3 3/3

2628 G-180IP	2.5; 2.0	180 mm	
8231 IP	51 mm	225 mm	
2430 G-200 IP		200 mm	
2101G-160IP		160 mm	

FF1E4002

Sicherungsringzangen



62,40 €

1/3 2/3 3/3

2900-180	180 mm	
2890-180	180 mm	
2990-180	180 mm	
2800-180	180 mm	

FF1E5003

Schlagwerkzeuge



54,60 €

1/3 2/3 3/3

481-300	300 g; 105x300x23 mm	
3735-5-120	120 mm - Ø 5 mm	
3739-300	300 mm	
3740-100	100 mm - 15 mm	
3740-125	125 mm - 15 mm	
3740-150	150 mm - 18 mm	
3740-200	200 mm - 23 mm	
3733	120 mm - Ø 2-4-6 mm	

Bestückte Werkzeugeinlagen: Maßgeschneidert. Anwenderorientiert.

Unsere Werkzeugaufbewahrungssysteme sind das Ergebnis unserer langjährigen Erfahrung in Zusammenarbeit mit Anwendern und Partnern aus Luftfahrt und Industrie – bedarfsgerecht und durchdacht erleichtern sie die tägliche Arbeit.

- Passend für alle Bahco Werkstattwagen und Bahco Werkbänke
- Große Auswahl an Modulen



BETMS Konfigurator
bahco.com/de_de/betms



Umweltfreundlich
gemäß EU-Richtlinien



Resistent: Wasser, Skydrol, Benzin



UV resistent



Stoß-absorbierend



100 % Kontrolle
2-farbiger Foam



Push-System

1/3

181 x 445 mm

2/3

362 x 445 mm

3/3

543 x 445 mm



2/3

FIT&GO MODULE

FF1F1003

Schlitz und Phillips ERGO™
Schraubendreher

11

83,20 €



BE-8030	⊙ 0.6x3.5x75	
BE-8242	⊙ 1.0x5.5x150	
BE-8252	⊙ 1.2x6.5x150	
BE-8155	⊙ 1.2x6.5x125	
BE-8870	⊙ 1.6x10.0x175	
BE-8600	⊙ PH0x60	
BE-8610	⊙ PH1x75	
BE-8620	⊙ PH2x100	
BE-8623	⊙ PH3x150	
BE-8624	⊙ PH4x200	
808050TS	⊙ 1/4" ⊕ 68 mm	

FF1F1004

TORX® ERGO™ Schraubendreher

10

57,20 €



BE-8904	⊙ T4 x75	
BE-8907	⊙ T7 x75	
BE-8908	⊙ T8 x75	
BE-7910	⊙ TR10 x75	
BE-7915	⊙ TR15 x100	
BE-7920	⊙ TR20 x100	
BE-7925	⊙ TR25 x125	
BE-7927	⊙ TR27 x125	
BE-7930	⊙ TR30 x150	
BE-7940	⊙ TR40 x150	

FF1F1007

TORX® Schraubendreher mit T-Griff

7

58,50 €



901T	⊙ T10x153; T15x186; T20x186; T25x196; T27x196; T30x245; T40x245	
7800SM	⊙ 1/2" ⊙ 10-12-13-17-18-19-20-21-22-24-27-30-32 mm	
7800DM	⊙ 1/2" ⊙ 10-11-12-13-14-15-16-17-18-19 mm	
7809M	⊙ 1/2" - 5-6-7-8-10-12 mm	
8150SL	⊙ 1/2" ⊙ 1/2" - ⊕ 265 mm	
8160-1/2	⊙ 1/2" ⊙ 1/2" - ⊕ 125 mm	
8162-1/2	⊙ 1/2" ⊙ 1/2" - ⊕ 250 mm	
8166-1/2	⊙ 1/2" ⊙ 1/2" - ⊕ 72 mm	
8154-1/2	⊙ 1/2" ⊙ 1/2" - ⊕ 283 mm	
8165-1/2	⊙ 1/2" ⊙ 3/8" - ⊕ 37 mm	

FF1F3003

Ring-Maulschlüssel und
Ratschenschlüssel

30

159,90 €



111M	6-7-8-9-10-11-12-13-14-15-16-17-18-19-20-21-22 mm	
1320SRM-14-19	⊕ 14-19 mm	
1RMA-19-1/2-SQ2	⊙ 1/2" -	
1RMA-19-1/4-SQ	⊙ 1/4" - ⊙ 19 mm	
1RMA-13-10-BIT	⊙ 10 mm - ⊙ 13 mm	
BE-9778	⊙ 1.5-2-2.5-3-4-5-6-8-10 mm	

FF1F3005

Knarren-Ring-Maulschlüssel

15

158,60 €



1RM	8-10-12-13-14-15-16-17-18-19-21-22 mm	
1RMA-13-10-BIT	⊙ 10 mm - ⊙ 13 mm	
1RMA-19-1/2-SQ2	⊙ 1/2" - ⊙ 19 mm	
1RMA-19-1/4-SQ	⊙ 1/4" - ⊙ 19 mm	

FF1F3008

Gelenkschraubenschlüssel

9

304,20 €



4040M	6-7-8-9-10-11-12-13-14-15-16-17-18-19-20-22-21-23 mm	
-------	--	--

FF1F4002

Zangen, Scheren, Gripszangen

8

144,30 €



2928-160	⊕ 160 mm	
2951-180	⊕ 2.0 - ⊕ 180 mm	
SC127	⊕ 130 mm	
2101G-160IP	⊕ 160 mm	
2430 G-160 IP	⊕ 160 mm	
2339 DIP	⊕ 2.5 - ⊕ 220 mm	
2628 G-180IP	⊕ 2.5; ⊕ 2.0 - ⊕ 180 mm	
8224 IP	⊕ 250 mm	

FF1F4004

Sicherungsringzangen

8

115,70 €

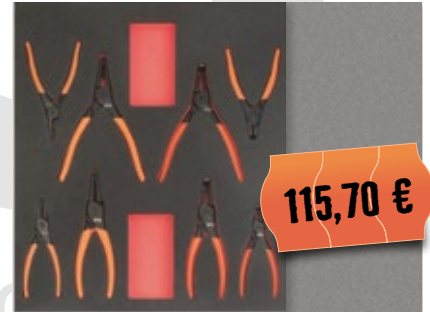

2800-140	⊕ 140 mm	
2800-180	⊕ 180 mm	
2890-140	⊕ 140 mm	
2890-180	⊕ 180 mm	
2900-140	⊕ 140 mm	
2900-180	⊕ 180 mm	
2990-140	⊕ 140 mm	
2990-180	⊕ 180 mm	

3/3 MODULE

FF1F4005

Isolierte Zangen und Wasserpumpenzange

5

128,70 €



	1/3	2/3	3/3
2101S-160	1,000 V -	160 mm	
2430 S-200	1,000 V -	200 mm	
2427 S-200	1,000 V -	200 mm	
8224 IP		250 mm	
2628 S-180	1,000 V -	180 mm	

FF1F5001

Feilen, Zangen, Messwerkzeuge

10

137,80 €



	1/3	2/3	3/3
1-100-08-1-2		150 mm-8"	
1-160-08-1-2		150 mm-8"	
1-170-08-1-2		200 mm-8"	
1-210-08-1-2		200 mm-8"	
1-230-08-1-2		200 mm-8"	
2430 G-200 IP		200 mm	
2628G-200IP	3.0; 2.5 -	200 mm	
7224		250 mm	
2101G-160IP		160 mm	
MTB-3-16	3 m -	16 mm	

FF1A1005

Schraubendreher, Bits und Winkelschraubendreher

66

180,70 €



	1/3	2/3	3/3
59S/31-1	1/4": PH1-PH2-PH3-PH2G; T25-T15-T20-T10-T27-T30; H3-H4-H5-H6; PZ1-PZ2-PZ3; 0.8x5.5-0.6x4.5-0.5x3.0; KM653-QR		
BE-8020		0.5 x 3.0 x 60	
BE-8240		0.8 x 4.0 x 175	
BE-8250		1.0 x 5.5 x 150	
BE-8255		1.2 x 6.5 x 150	
BE-8865		1.6 x 8.0 x 175	
BE-8602		PH2 x 25	
BE-8611		PH1 x 75	
BE-8621		PH2 x 100	
BE-8630		PH3 x 150	
BE-9585		T9-T10-T15-T20-T25-T27-T30-T40	
BE-8800		PZ0 x 60	
BE-8811		PZ1 x 75	
BE-8821		PZ2 x 100	
BE-8802		PZ2 x 25	
BE-8830		PZ3 x 150	
BE-8910		T10 x 75	
BE-8915		T15 x 100	
BE-8920		T20 x 100	
BE-8925		T25 x 125	
BE-9678		1.5-2-2.5-3-4-5-6-8-10 mm	

FF1A3004

Ring-Maulschlüssel und Knarren-Ring-Maulschlüssel

30

247,00 €



	1/3	2/3	3/3
111M	6-7-8-9-10-11-12-13-14-15-16-17-18-19-20-21-22-24 mm		
1RM	8-9-10-11-12-13-14-15-16-17-18-19 mm		

Das umfassende Sortiment an bestückten Werkzeugeinlagen – Im Bahco Online-Katalog:



Stellen Sie Ihren maßgeschneiderten Werkstattwagen aus mehr als **200 Modulen** mit unterschiedlichen Werkzeugsortimenten in den Modulgrößen 1/3, 2/3, 3/3 zusammen.

1/3

181 x 445 mm

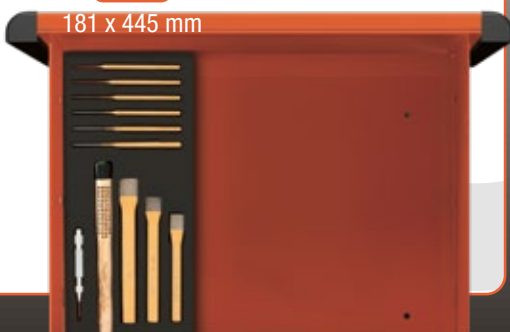

2/3

362 x 445 mm

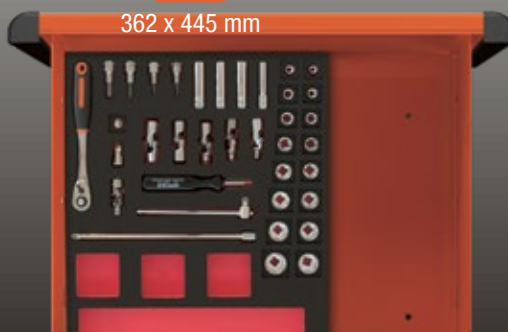

3/3

543 x 445 mm

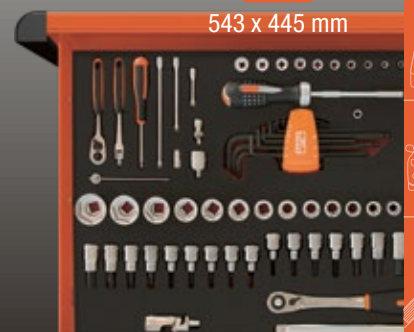

WERKSTATTWAGEN



Rutschfeste Gummi-Arbeitsfläche



Schubladen mit Rollenvollauszug



Hohe Tragkraft



Kantenschutz



Ø125 x 36 mm



Zentralverschluss-System mit Rundschlüssel



Serie 1472K Werkstattwagen, leer

Serie 1482K Werkzeugaufsätze, leer

- Hohe Stabilität durch doppelwandigen Rahmen
- Rand verhindert Herabfallen von Werkzeugen und Teilen



1482K	510 mm	385 mm	690 mm
1472K	510 mm	950 mm	690 mm

Standard RAL-Farben





1472K5
 Innenmaße der Schubladen:
 (1x) 543 x 445 x 53 mm
 (2x) 543 x 445 x 118 mm
 (2x) 543 x 445 x 184 mm

1472K6
 Innenmaße der Schubladen:
 (3x) 543 x 445 x 53 mm
 (2x) 543 x 445 x 118 mm
 (1x) 543 x 445 x 249 mm

1472K7
 Innenmaße der Schubladen:
 (5x) 543 x 445 x 53 mm
 (1x) 543 x 445 x 118 mm
 (1x) 543 x 445 x 249 mm

1472K8
 Innenmaße der Schubladen:
 (6x) 543 x 445 x 53 mm
 (1x) 543 x 445 x 118 mm
 (1x) 543 x 445 x 184 mm

Artikelnummer	Schubladen	Farbe		
1472K5	5	Orange	■	RAL 2009
1472K5BLACK	5	Schwarz	■	RAL 9005
1472K5BLUE	5	Blau	■	RAL 5002
1472K5RED	5	Rot	■	RAL 3001
1472K5GREY	5	Grau	■	RAL 9022
1472K5WHITE	5	Weiß	■	RAL 9003
1472K6	6	Orange	■	RAL 2009
1472K6BLACK	6	Schwarz	■	RAL 9005
1472K6BLUE	6	Blau	■	RAL 5002
1472K6RED	6	Rot	■	RAL 3001
1472K6GREY	6	Grau	■	RAL 9022
1472K6WHITE	6	Weiß	■	RAL 9003

Artikelnummer	Schubladen	Farbe		
1472K7	7	Orange	■	RAL 2009
1472K7BLACK	7	Schwarz	■	RAL 9005
1472K7BLUE	7	Blau	■	RAL 5002
1472K7RED	7	Rot	■	RAL 3001
1472K7GREY	7	Grau	■	RAL 9022
1472K7WHITE	7	Weiß	■	RAL 9003
1472K8	8	Orange	■	RAL 2009
1472K8BLACK	8	Schwarz	■	RAL 9005
1472K8BLUE	8	Blau	■	RAL 5002
1472K8RED	8	Rot	■	RAL 3001
1472K8GREY	8	Grau	■	RAL 9022
1472K8WHITE	8	Weiß	■	RAL 9003

Werkzeugaufsatz, leer

1482K4
 Innenmaße der Schubladen:
 (3x) 543 x 445 x 53 mm
 (1x) 543 x 445 x 118 mm



285,00 €

Artikelnummer	Schubladen	Farbe		
1482K4	4	Orange	■	RAL 2009
1482K4BLACK	4	Schwarz	■	RAL 9005
1482K4BLUE	4	Blau	■	RAL 5002
1482K4RED	4	Rot	■	RAL 3001
1482K4GREY	4	Grau	■	RAL 9022
1482K4WHITE	4	Weiß	■	RAL 9003

Zubehör für Serie 1472K / 1482K



Artikelnummer	Beschreibung	€
1477K-AC18	Papierrollenhalter	26,00
1477K-AC19	Seitenfach	24,70
1477K-AC20	Spraydosenhalter	22,10

Artikelnummer	Beschreibung	€
1477K-AC21	Halter für Druckluftwerkzeuge	44,20
1477K-AC22	Seitenlochwand	37,70
1470KAC01	Antirutschmatte für Schubladen	14,30

WERKSTATTWAGEN

Serie 1475K, 1485K

Werkstattwagen und Aufsätze, leer

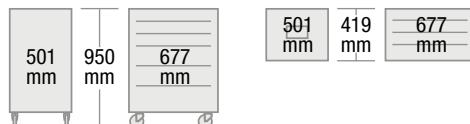

STOP
Ø 125 x 30 mm

409,00 €

57 kg

6

419,00 €

60 kg

7

429,00 €

62 kg

8

299,00 €

40 kg

4

Hohe Tragkraft
30 KG
600 KG

1475K6

Innenmaße der Schubladen:
(3x) 543 x 445 x 53 mm
(2x) 543 x 445 x 118 mm
(1x) 543 x 445 x 249 mm

1475K7

Innenmaße der Schubladen:
(5x) 543 x 445 x 53 mm
(1x) 543 x 445 x 118 mm
(1x) 543 x 445 x 249 mm

1475K8

Innenmaße der Schubladen:
(6x) 543 x 445 x 53 mm
(1x) 543 x 445 x 118 mm
(1x) 543 x 445 x 184 mm

1485K4

Werkzeugaufsatz
Innenmaße der Schubladen:
(3x) 543 x 445 x 53 mm
(1x) 543 x 445 x 118 mm

Artikelnummer	Schubladen	Farbe
1475K6	6	Orange RAL 2009
1475K6BLACK	6	Schwarz RAL 9005
1475K6BLUE	6	Blau RAL 5002
1475K6RED	6	Rot RAL 3001
1475K7	7	Orange RAL 2009
1475K7BLACK	7	Schwarz RAL 9005
1475K7BLUE	7	Blau RAL 5002
1475K7RED	7	Rot RAL 3001

Artikelnummer	Schubladen	Farbe
1475K8	8	Orange RAL 2009
1475K8BLACK	8	Schwarz RAL 9005
1475K8BLUE	8	Blau RAL 5002
1475K8RED	8	Rot RAL 3001
1485K4	4 – Aufsatz	Orange RAL 2009
1485K4BLACK	4 – Aufsatz	Schwarz RAL 9005
1485K4BLUE	4 – Aufsatz	Blau RAL 5002
1485K4RED	4 – Aufsatz	Rot RAL 3001

Standard RAL-Farben



Tragegriffe

677 mm

419 mm

960 mm

Werkstattwagen 1475K8 mit Aufsatz 1485K4

WERKSTATTWAGEN

Serie 1475KXL Werkstattwagen XL

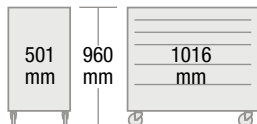

1016 mm



1475KXL6

Werkstattwagen XL mit 6 Schubladen

Innenmaße der Schubladen:
(2x) 881 x 445 x 53 mm
(3x) 881 x 445 x 118 mm
(1x) 881 x 445 x 184 mm

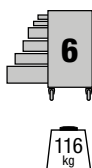
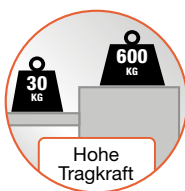

Artikelnummer	Schubladen	Farbe
1475KXL6	6	Orange ■ RAL 2009
1475KXL6BLACK	6	Schwarz ■ RAL 9005
1475KXL6BLUE	6	Blau ■ RAL 5002
1475KXL6RED	6	Rot ■ RAL 3001



1475KXL6C

Werkstattwagen XL mit 6 Schubladen und Schrank

Innenmaße der Schubladen:
(3x) 543 x 445 x 53 mm
(2x) 543 x 445 x 118 mm
(1x) 543 x 445 x 249 mm

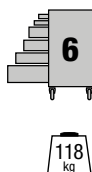

Artikelnummer	Schubladen	Farbe
1475KXL6C	6	Orange ■ RAL 2009
1475KXL6CBLACK	6	Schwarz ■ RAL 9005



1475KXL12

Werkstattwagen XL mit 12 Schubladen

Innenmaße der Schubladen
(1x) 881 x 445 x 53 mm
Linke Schubladen
(4x) 284 x 445 x 53 mm
(1x) 284 x 445 x 118 mm
(1x) 284 x 445 x 184 mm

Rechte Schubladen
(2x) 540 x 445 x 53 mm
(2x) 540 x 445 x 118 mm
(1x) 540 x 445 x 184 mm

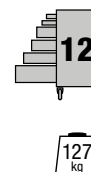
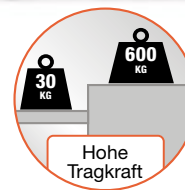

Artikelnummer	Schubladen	Farbe
1475KXL12	12	Orange ■ RAL 2009
1475KXL12BLACK	12	Schwarz ■ RAL 9005

WERKSTATTWAGEN

Arbeitsflächen für Serie 1475K / 1470K

■ Passend für die 26" Werkstattwagen 1475K / 1470KSS bzw. die 40" Werkstattwagen 1475KXL



1470K-ACTSS
26" Edelstahl Arbeitsfläche



1470KXL-ACTSS
40" Edelstahl Arbeitsfläche

1470K-ACTW
26" Holz Arbeitsfläche

1470KXL-ACTW
40" Holz Arbeitsfläche



1470K-ACTD
26" MDF Arbeitsfläche



1470KXL-ACTD
40" MDF Arbeitsfläche



1470K-AC7
26" Kunststoff Arbeitsfläche mit Kleinteilefächern

Artikelnummer	Beschreibung	€
1470K-ACTSS	26" Edelstahl Arbeitsfläche	239,00
1470KXL-ACTSS	40" Edelstahl Arbeitsfläche	328,00
1470K-ACTW	26" Holz Arbeitsfläche	222,00
1470KXL-ACTW	40" Holz Arbeitsfläche	279,00

Artikelnummer	Beschreibung	€
1470K-ACTD	26" MDF Arbeitsfläche	144,00
1470KXL-ACTD	40" MDF Arbeitsfläche	179,00
1470K-AC7	26" Kunststoff Arbeitsfläche	98,00

Zubehör für Serie 1475K / 1470K



1470K-AC1
Seitenablage



1470K-AC2
Werkzeughalter



1470K-ACSIDE
Seitenlochwand



1470K-AC3
Spraydosenhalter



1470K-AC4
Seitenfach



1470KAC01
Antirutschmatte für Schubladen



1470K-AC8
Lochrückwand

Artikelnummer	Beschreibung	€
1470K-AC1	Seitenablage	82,00
1470K-AC2	Werkzeughalter	99,00
1470K-AC3	Spraydosenhalter	35,00
1470K-AC4	Seitenfach	42,00

Artikelnummer	Beschreibung	€
1470K-ACSIDE	Seitenlochwand	69,00
1470K-AC8	Lochrückwand orange	82,00
1470KAC01	Antirutschmatte für Schubladen	14,00



WERKSTATTWAGEN MIT SORTIMENT

1472K6BKFF7SD

Werkstattwagen mit 6 Schubladen bestückt mit 214 Werkzeugen

■ 3/3 Werkzeugmodule 543 x 445 mm

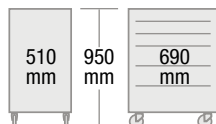
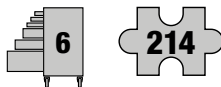

589,00 €

FF1A81

Schraubendreher & Schraubenschlüssel



B191.040.100	⌀ 4.0x0.8x100	
B190.055.125	⌀ 5.5x1.2x125	
B190.065.150	⌀ 6.5x1x150	
B192.000.075	PH0x75	
B192.001.100	PH1x100	
B192.002.125	PH2x125	
111M	6-7-8-9-10-11-12-13-14-15-16-17-19-21-22-24 mm	
BE-9770-B	1.5-2-2.5-3-4-5-6-8-10 mm	

FF1A82

Schlagwerkzeuge & Zangen



3734S/6-T	⌀ 2-3-4-5-6-8 mm; 150 mm	
479-16	450 g	
3625W-35	⌀ 35 mm	
MTG-3-16	3 m; 16 mm	
KB18-01	18x161 mm	
KSBG18-10 DISPEN	18 mm, x10	

2101G180	180 mm	
2678G-180	2.0; 1.4; 180 mm	
2470G-200	200 mm	
2530	350 mm	
8224	250 mm	

FF1A179

Steckschlüssel und Zubehör



1/4" + 1/2"

2058-BR	1/4", 8 mm	
59/S100B-T	1/4": 4.5-5.5; PH1(x2)-PH2(x9)-PH3-PH2G(x5); PZ1(x2)-PZ2(x9)-PZ3, T10(x3)-T15(x5)-T20(x15)-T25(x8)-T27-T30(x15)-T40(x3)-TR10-TR15-TR20-TR25-TR30; HEX3-HEX4(x3)-HEX5-HEX6(x3)-HEX8; R1-R2	
6950SL	1/4", 1/4" - 120 mm	
8150SL	1/2", 1/2" - 265 mm	
6700SM	1/4", 4-4.5-5-5.5-6-7-8-9-10-11-12-13-14 mm	
A6800DM	1/4", 7-8-9-10-11-13 mm	
6956	1/4", 1/4" - 150 mm	
6961	1/4", 1/4" - 100 mm	
6966	1/4", 1/4" - 35 mm	

7800SM	1/2", 10-11-12-13-14-15-16-17-18-19-20-21-22-24-27-30-34 mm	
7805DM	1/2", 10-13-17-18-19-16-21-22 mm	
7805SM	1/2", 16-21 mm	
8160-1/2	1/2", 1/2" - 125 mm	
8162-1/2	1/2", 1/2" - 250 mm	
8166-1/2	1/2", 1/2" - 72 mm	
8156-1/2	1/2", 1/2" - 257 mm	
7106S0080	1/2", 5/16"	
6973	1/4", 1/4"	
70S	5/16" - T45-T50-T55	

WERKSTATTWAGEN MIT SORTIMENT

1472K6/S1

Werkstattwagen mit 6 Schubladen bestückt mit 177 Werkzeugen

■ 3/3 Werkzeugmodule 543 x 445 mm

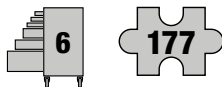

1.399,00 €

FF1A04

Schraubenschlüssel



S4RM	8-11-12-15-16-19 mm	
111M	6-7-8-9-10-11-12-13-14-15-16-17-18-19-21-22-24-27-32 mm	
6M	6-7-8-9-10-11-12-13-14-15-17-19 mm	
9071C	27 mm; 208 mm / 8"	

FF1A05

Steckschlüssel und Zubehör



BE-9678	1.5-2-2.5-3-4-5-6-8-10 mm	
SBS60	1/4" 4-4.5-5-5.5-6-7-8-9-10-11-12-13-14 mm	
SBS61	1/4" 145 mm	
SBS63-2	1/4" 150 mm	
SBS63-4	1/4" 100 mm	
SBS63-6	1/4" 150 mm	
SBS64	1/4" 1/4" 125 mm	
SBS65	1/4" 1/2" 32.5 mm	
SBS67	1/4" 153 mm	
SBS69	1/4" 3/8" 25 mm	
SBS80	1/2" 10-11-12-13-14-15-16-17-18-19-21-22-24-27-30-32 mm	
SBS88	1/2" 3/8" 37 mm	

59S/31-1	1/4": PH1-PH2-PH3-PH2G; T25-T15-T20-T10-T27-T30; H3-H4-H5-H6; P21-P22-P23; 0.8x5.5-0.6x4.5-0.5x3.0; KM653-QR	
6956	1/4" 150 mm	
6972H	1/4" 26 mm	
7809M	1/2" 5-6-7-8-10-12-14-17-19 mm	
7809TORX	1/2" T20-T25-T27-T30-T40-T45-T50-T55-T60	
808050	1/4" 125 mm	
8150SL	1/2" 265 mm	
8154-1/2	1/2" 283 mm	
8160-W	1/2" 125 mm	
8162-1/2	1/2" 250 mm	
8166-1/2	1/2" 72 mm	

FF1A06

Schraubendreher und Zangen



BE-8020L	0.5 x 3.0 x 75	
BE-8040	0.8 x 4.0 x 100	
BE-8150	1.0 x 5.5 x 100	
BE-8255	1.2 x 6.5 x 150	
BE-8256	1.6 x 8.0 x 150	
BE-8350	1.0 x 5.5 x 25	
BE-8601	PH1 x 25	
BE-8610	PH1 x 75	
BE-8620	PH2 x 100	
BE-8910	T10 x 75	
BE-8915	T10 x 100	
BE-8920	T20 x 100	
BE-8925	T25 x 125	
BE-8927	T27 x 125	
BE-8930	T30 x 150	

MTB-3-16	3 m; 16 mm	
2101B-160IP	160 mm	
2427 G-200 IP	200 mm	
2535L	20 mm	
2628 G-160IP	1.8; 2.0; 160 mm	
2951-180	2.0; 180 mm	
5515T-52	30 mm; 180-690 mm	
8224 IP	250 mm	

FF1A07

Feilen, Schlagwerkzeuge & Metallsäge



3734N	150 mm - 3-5-6 mm	
3735N-4-120	120 mm - 4 mm	
3740-175	175 mm - 21 mm	
SQZ150003	170 mm	
1-100-08-2-2	200 mm	
1-210-08-2-2	200 mm	
1-230-08-2-2	200 mm	
2744	190 mm	

3625W-35	35 mm; 100x300 mm	
3745-150	150 mm; 6 mm; 17x11 mm	
481-400	400 g; 112x300x25 mm	
782-U	290 mm	
317	432 mm / 17"	

Fit & go SYSTEM
Die Einlagen sind auch einzeln erhältlich.

1472K7/S1

Werkstattwagen mit 7 Schubladen bestückt mit 300 Werkzeugen

3/3 Werkzeugmodule 543 x 445 mm

Fit & go Die Einlagen sind auch einzeln erhältlich.

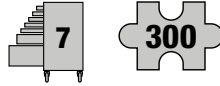

2.299,00 €



FF1A08

Steckschlüssel und Zubehör



1/4"
3/8"
1/2"

A6800DM	1/4"	5.5-6-7-8-9-10-11-12-13 mm	
A7402DM	1/4"	10-11-12-13-14-15-16-17-18-19 mm	
1544		76 mm - 0.03-1.00 mm	
6700SM	1/4"	5.5-6-7-8-9-10-11-12-13 mm	
6709M	1/4"	3-4-5-6-8 mm	
6709PH	1/4"	PH1-PH2-PH3	
6709TORX	1/4"	T8-T9-T10-T15-T20-T25-T27-T30-T40	
6950SL	1/4"	120 mm	
6954	1/4"	115 mm	
6956	1/4"	150 mm	
6958	1/4"	153 mm	
6960	1/4"	50 mm	
6961	1/4"	101 mm	
6962	1/4"	152 mm	
6962L	1/4"	335 mm	
6966	1/4"	35 mm	
6972H	1/4"	26 mm	
7400SM	1/4"	6-7-8-9-10-11-12-13-14-15-16-17-18-19-22 mm	
7407H	1/4"	26 mm	
7409M	3/8"	3-4-5-6-7-8-10 mm	
7409TORX	3/8"	T25-T27-T30-T40-T45-T50	
7750SL	3/8"	205 mm	
7754	3/8"	160 mm	
7758	3/8"	250 mm	
7760	3/8"	75 mm	
7761	3/8"	127 mm	
7762	3/8"	252 mm	
7764	3/8"	24,7 mm	
7765	1/4"	25 mm	
7766	3/8"	51,5 mm	
7800SM	1/2"	10-11-12-13-14-15-16-17-18-19-21-22-24-27-30-32 mm	
7807H	1/4"	38 mm	
7809M	1/2"	5-6-7-8-10-12-14-17-19 mm	
7809TORX	1/2"	T20-T25-T27-T30-T40-T45-T50-T55-T60	
8150SL	1/2"	265 mm	
8154-1/2	1/2"	283 mm	
8160-1/2	1/2"	125 mm	
8162-1/2	1/2"	250 mm	
8164-1/2	3/8"	33 mm	
8165-1/2	1/2"	37 mm	
8166-1/2	1/2"	72 mm	
8964	1/2"	45 mm	

FF1A09

Schraubenschlüssel



111M	6-7-8-9-10-11-12-13-14-15-16-17-18-19-21-22-24-27-30-32 mm	
1320RM	8-9-10-11-12-13 mm	
6M	6-7-8-9-10-11-12-13-14-15-16-17-18-19-20-22-24-27-30-32 mm	
9071C	27 mm; 208 mm / 8"	

FF1A10

Schraubendreher und Messwerkzeuge



BE-8020L	0.5 x 3.0 x 75	
BE-8030	0.6 x 3.5 x 75	
BE-8155	1.2 x 6.5 x 125	
BE-8260	1.6 x 8.0 x 175	
BE-8350	1.0 x 5.5 x 25	
BE-8601	PH1 x 25	
BE-8602	PH2 x 25	
BE-8610	PH1 x 75	
BE-8620	PH2 x 100	
BE-8630	PH3 x 150	
BE-8910	T10 x 75	
BE-8915	T15 x 100	
BE-8920	T20 x 100	
BE-8925	T25 x 125	
BE-8927	T27 x 125	
BE-8930	T30 x 150	
BE-8940	T40 x 150	
BE-9770	1.5-2-2.5-3-4-5-6-8-10 mm	
MTB-3-16	3 m; 16 mm	
1150-112H/P	235 x 75 x 9	
1177-SCRIBE	70°; 230 mm	
2820EF2	200 mm	
5515T-52	30 mm; 180-690 mm	
59S/31-1	1/4"; PH1-PH2-PH3-PH2G; T25-T15-T20-T10-T27-T30; H3-H4-H5-H6; PZ1-PZ2-PZ3; 0.8x5.5-0.6x4.5-0.5x3.0; KM653-QR	
808050S	1/4"; 68 mm	
2047-0-8-4	100 mm	
2047PR-1-2	PH1-2 x 100 mm	

FF1A12

Zerspanungs- und Schlagwerkzeuge



FS-8	165 mm	
1-100-06-1-2	150 mm	
1-100-06-2-2	150 mm	
1-160-06-1-2	150 mm	
1-210-06-1-2	150 mm	
1-230-06-1-2	150 mm	
2509	525 mm	
2535F2	10 mm; 535 mm	
3625W-35	35 mm; 100x300 mm	
3734	150 mm; 3-5-8 mm	
3735-4-120	120 mm; 4 mm	
3740-150	150 mm; 18 mm	
3745-150	150 mm; 6 mm	
481-300	300 g; 105x300x23 mm	
481-500	500 g; 118x300x27 mm	
8158-1/2	1/2"; 390 mm	
319	300 mm / 11"	

FF1A11

Zangen



2101GC-125IP	125 mm	
2101GC-160IP	160 mm	
21HDGC-200IP	200 mm	
2427 GC-200IP	200 mm	
2430 GC-200 IP	200 mm	
2628 GC-160IP	2.0; 1.8; 160 mm	
2928	160-200-250 mm	
2951-250	3.0; 250 mm	
2952-165	165 mm	
8224CIP	250 mm	

EDELSTAHL WERKZEUGE

EDELSTAHL®
Rost
frei



Edelstahlwerkzeuge werden überall dort eingesetzt, wo sogenannter „Fremdrost“ zu erheblichen optischen Beeinträchtigungen von Edelstahloberflächen oder sogar zu Sicherheitsmängeln wie Lochfraß führen kann.

Werkzeuge aus rostfreiem Edelstahl finden in den folgenden Branchen bereits Anwendung:

- Lebensmittelindustrie
- Luft- und Raumfahrt
- Medizintechnik
- Pharmaindustrie
- Chemieindustrie
- Automobiltechnik
- Und überall dort, wo Arbeiten unter sterilen oder Reinraum Bedingungen erfolgen müssen

Alle Produkte sind aus AISI 420 Edelstahl





Edelstahlgriff kann an beiden Seiten befestigt werden

1.399,00 €

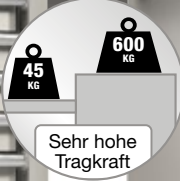

65 kg



1.795,00 €

121 kg



1470K7SS

Edelstahl Werkstattwagen mit 7 Schubladen



Innenmaße der Schubladen:

- (5x) 543 x 445 x 53 mm
- (1x) 543 x 445 x 118 mm
- (1x) 543 x 445 x 249 mm

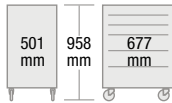

1475KXL7SS

Edelstahl Werkstattwagen XL mit 7 Schubladen



Innenmaße der Schubladen:

- (5x) 881 x 445 x 53 mm
- (1x) 881 x 445 x 118 mm
- (1x) 881 x 445 x 249 mm

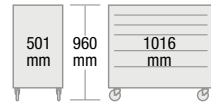

Schubladen und Führungsschienen aus Edelstahl, Griffe aus Aluminium

Um die Edelstahlwerkzeuge geordnet im Werkstattwagen zu verstauen, gibt es die Möglichkeit, Einlagen aus PMMA Altuglas® zu verwenden. Kontaktieren Sie uns.



EDELSTAHL WERKZEUGE



Edelstahl Ring-Maulschlüssel

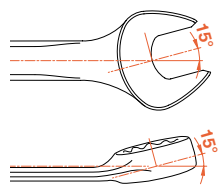

- ISO 691
- Hohe Stärke und Härte
- Extrem korrosionsbeständig

BAHCO	mm	mm	g	€
SS002-6	6	105	25	14,70
SS002-8	8	120	25	18,15
SS002-10	10	120	25	22,10
SS002-11	11	135	45	23,80
SS002-12	12	135	45	25,50
SS002-13	13	150	60	26,55
SS002-14	14	150	60	27,40
SS002-15	15	175	80	28,80
SS002-16	16	175	70	30,30
SS002-17	17	195	115	31,10
SS002-19	19	195	115	33,15
SS002-21	21	195	110	41,40
SS002-22	22	215	160	43,30
SS002-24	24	215	160	49,95
SS002-27	27	215	160	70,95

Edelstahl Rollgabelschlüssel

- ISO 6787



- Hohe Stärke und Härte
- Extrem korrosionsbeständig

BAHCO	mm	mm	g	€
SS001-100	13	100	100	41,25
SS001-150	18	150	120	52,55
SS001-200	24	200	240	70,45
SS001-250	30	250	400	86,90
SS001-300	36	300	340	112,20
SS001-375	46	375	1360	169,00
SS001-450	55	450	1840	213,00
SS001-600	60	600	3200	378,00



231,00 €

SS002-9-2 Edelstahl Ring-Maulschlüssel Satz

mm 8 10 11 12 13 14 15 17 19

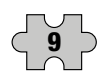

BE-9770i Edelstahl-Winkelschraubendreher-Satz



- Mit Kugelkopf für besseren Zugang



M 1.5 2 2.5 3 4 5 6 8 10



14,95 €

EDELSTAHL WERKZEUGE



BE-9881i ERGO™ Edelstahl Schraubendreher-Satz

6

ISO 2380 / DIN 5264

0.5x3.0 mm 1.0x5.5 mm
0.8x4.0 mm 1.2x6.5 mm

PH1
PH2

ergo®

Edelstahl Rostfrei



23,95 €

Ergonomische Dreikomponenten-Griffe

ERGO™ Edelstahl Schraubendreher für Phillips® Schrauben

ergo®

Edelstahl Rostfrei

+



BAHCO	mm	mm	mm	€
BE-8610i	⊕ PH 1 x 75	27 x 122	197	7,95
BE-8620i	⊕ PH 2 x 100	36 x 122	222	10,55

Edelstahl Wasserpumpenzangen

PVC-ummantelte Griffe

Edelstahl Rostfrei



G

Hohe Festigkeit und Härte

- ISO 8976
- Äußerst korrosionsbeständig

7 Positionen

BAHCO	max mm	mm	g	€
SS410-250	36	250	380	94,30
SS410-300	50	300	450	141,50

Edelstahl Seitenschneider

Edelstahl Rostfrei

- ISO 5749
- Äußerst korrosionsbeständig

G

Hohe Festigkeit und Härte

PVC-ummantelte Griffe

BAHCO	mm	CU mm	Fe mm	g	€
SS402-160	160	0.8*	0.8*	130	63,00
SS402-200	195	0.8*	0.8*	335	68,70

651/7-1 Edelstahl-Bitsatz

7

1/4" DIN 3126-C6.3, ISO 1173

Edelstahl Rostfrei

- ⊕ PH2 ⊕ PZ2
- ⊕ T15 T20 T25 T30
- 1/4" 1/4"



16,70 €

WERKZEUGE MIT ABSTURZSICHERUNG

Vermeidung von Unfällen durch herunterfallende Werkzeuge bei Arbeiten in größeren Höhen

Werkzeuge mit Absturzsicherung werden in vielen verschiedenen Bereichen wie im Hochbau, Arbeiten an Windkraftanlagen oder von Industriekletterern verwendet. Der Einsatz der Werkzeuge gewährleistet einen zuverlässigen Schutz vor Herunterfallen und verhindert somit schwere Verletzungen, Sachschäden oder Verlust des Werkzeugs. Bahco hat für jedes Werkzeug die beste Lösung für die Arbeit in der Höhe entwickelt.

Bahco ist Mitglied von DROPS (dropped objects prevention scheme), eine branchenweite Initiative, die sich mit der Vermeidung von Unfällen durch herabfallende Objekten befasst. Alle unsere Werkzeuglösungen sind nach den DROPS-Richtlinien zugelassen.



Farberkennungssystem zur Bestimmung des Maximalgewichts



DROPS

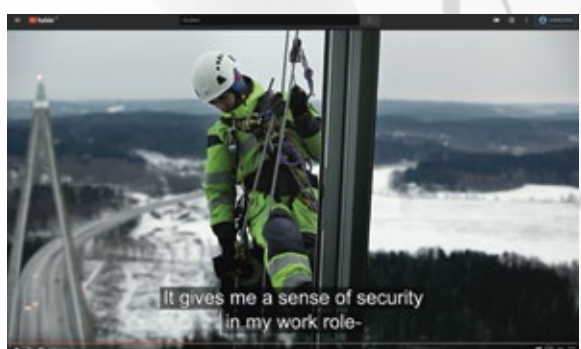

Bahco Professionals: Magnus Strömhall - Climber - YouTube



<https://youtu.be/Ci2F7dLXOLI>

3875-LY5 Sicherungsleine

max. 1,40 m

max. 1 KG

Farberkennungssystem

DROPS

11,15 €

Ring-Maulschlüssel mit Sicherheitsfeder

- Hochleistungs-Stahllegierung

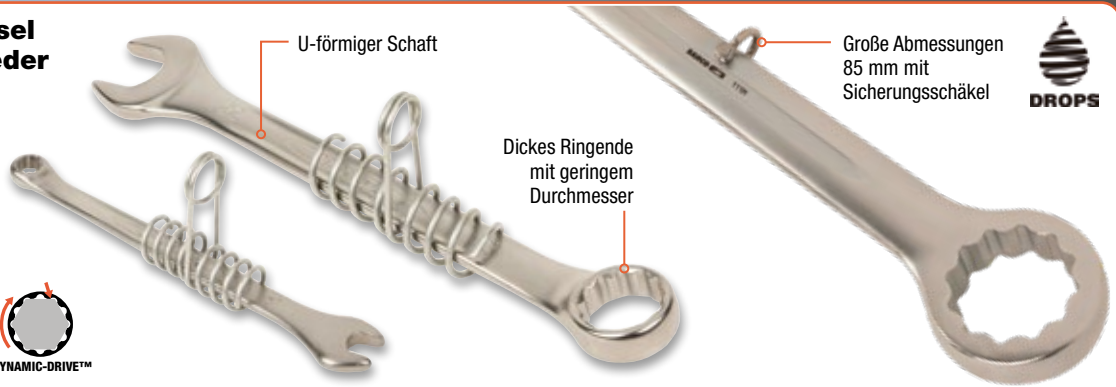
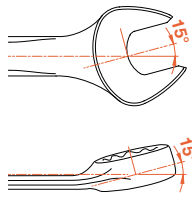

BAHCO	mm	mm	g	€
TAH111M-6	6	112	30	11,35
TAH111M-7	7	120	30	10,35
TAH111M-8	8	130	40	10,35
TAH111M-9	9	136	40	10,35
TAH111M-10	10	144	50	11,05
TAH111M-11	11	153	60	11,15
TAH111M-12	12	160	70	11,30
TAH111M-13	13	165	100	11,65
TAH111M-14	14	177	110	11,85
TAH111M-15	15	185	120	12,05
TAH111M-16	16	195	130	10,85
TAH111M-17	17	200	145	11,05
TAH111M-18	18	208	170	15,00
TAH111M-19	19	215	180	11,85
TAH111M-20	20	240	210	13,60

BAHCO	mm	mm	g	€
TAH111M-21	21	250	240	13,75
TAH111M-22	22	250	240	14,45
TAH111M-23	23	270	310	23,25
TAH111M-24	24	270	320	14,95
TAH111M-25	25	290	345	16,00
TAH111M-27	27	310	470	17,45
TAH111M-30	30	330	530	20,70
TAH111M-32	32	345	590	22,10
TAH111M-34	34	347	570	23,05
TAH111M-36	36	400	870	38,40
TAH111M-41	41	438	1130	53,05
TAH111M-46	46	500	1790	68,15
TAH111M-50	50	540	2200	88,40
TAH111M-55	55	560	2800	164,00
TAH111M-85	85	780	9370	553,00

ERGO™ Rollgabelschlüssel mit Karabinerhaken



- Brüniert, präzisionsgehärtet und rostschutzbehandelt
- ISO 6787, DIN 3117, ASME B107.8M - 1996 and BS 6333



BAHCO	mm	mm	mm	g	€
TAH9070	20	4,9	158	150	34,65
TAH9072	31	9	250	500	31,15

4750-HDLB-TAH Ledergürtel

39,70 €



- 6 Ringe zur Befestigung von Werkzeugen und anderen Gegenständen

4750-UP-2 Universaltasche



43,80 €

- 4 Halteringe für Sicherheitsleinen

WERKZEUGE MIT ABSTURZSICHERUNG

ERGO™ Seitenschneider mit Sicherheitsring



- ISO 5749
- Brüniert



BAHCO	mm	Fe+ mm	g	€
TAH2101G-125	130	1.8	100	43,25
TAH2101G-140	145	2.0	140	43,25
TAH2101G-160	165	2.5	180	44,25
TAH2101G-180	185	2.7	245	44,35

ERGO™ Hochleistungs-Seitenschneider, mit Sicherheitsring



- ISO 5749
- Brüniert



BAHCO	mm	Fe+ mm	g	€
TAH21HDG-200	210	3.2	270	43,35

TAH481 Schlosserhammer mit Drahtschleife



- DIN 1041
- Erstklassiger Eschenstiel

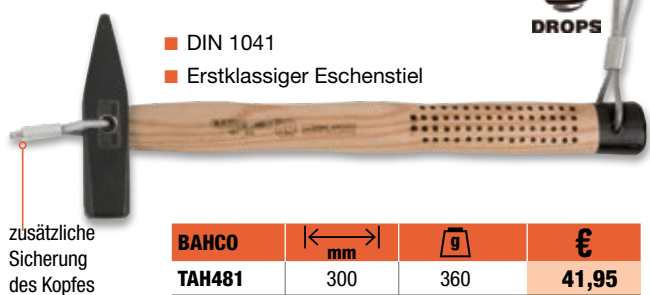

BAHCO	mm	g	€
TAH481	300	360	41,95

TAH8224 ERGO™ Wasserpumpenzange mit Sicherheitsring



- ISO 8976
- Brüniert



BAHCO	mm	mm	g	€
TAH8224	45	250	360	41,95

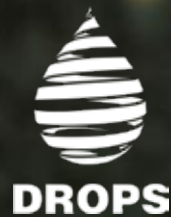

WINDKRAFTANLAGEN WERKZEUGKOFFER

4750RCHDW02
Stabiler Hartschalenkoffer aus Polypropylen mit Rollen und Teleskopgriff

630 x 480 x 290 mm



-33 °C – +90 °C



1.899,00 €



1.899,00 €

4750RCHDW02FF15

Hartschalenkoffer inklusive Werkzeug zur Wartung von Windkraftanlagen

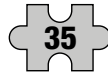

4750RCHDW02FF4

Hartschalenkoffer inklusive Werkzeug zur allgemeinen Wartung von Windkraftanlagen



TAH1177-SCRIBE 230 mm	TAH3625W-35 Ø + 35 mm
TAHBE-8985 Ø + 2 mm	TAH481-300 300 g
TAHBE-8020L 0,5x3x7	TAH2484-30 300 mm
TAHBE-8030 0,6x3,5x7,5	TAH3734BM-3, 5, 8 mm
TAHBE-8155 1,2x6,5x125	TAH3756BM-4 4 mm
TAHBE-8280 1,6x8,0x175	TAH7005M-1/4" 5, 5, 6, 7, 8, 9, 10, 11, 12, 13 mm
TAHBE-8610 PH1x75	TAH6950 1/4"
TAHBE-8620 PH2x100	TAH6956 1/4" 150 mm
TAHBE-8630 PH3x150	TAH6958 1/4" 153 mm
TAHBE-8620 PH2x100	TAH6960 1/4" 50 mm
TAHBE-8630 PZ3x150	TAH6961 1/4" 100 mm
TAHBE-8610S PH1x80	TAH6962 1/4" 355 mm
TAHBE-8620S PH2x100	TAH6966 1/4" 35 mm
TAH111M-17 mm	MTS-5-25 25 mm
TAH111M-17 mm	TAH168 1/2" 10, 11, 12, 13, 14, 15, 16, 17, 18, 19, 21, 22, 24, 27, 30, 32 mm
TAH111M-17 mm	TAH1610 1/2" 5, 6, 7, 8, 10, 12, 14, 17, 19 mm
TAH111M-17 mm	TAH16 1/2" T40, T45, T50, T55, T60
TAH111M-17 mm	TAH150-1/2" 1/2"
TAH111M-17 mm	TAH158B-1 1/2" 390 mm
TAH111M-17 mm	TAH160 1/2" 125 mm
TAH111M-17 mm	TAH162 1/2" 250 mm
TAH111M-17 mm	TAH166 1/2" 72 mm

TAH1210-06-2-2 150 mm	TAHBE-977B 2,5, 3, 4, 5, 6, 8, 10 mm	TAH3625W-35 Ø + 35 mm
TAHBE64520 60-160 mm	TAH111M-18, 19, 21, 22, 24, 27, 30, 32 mm	TAH481-300 300 g
TAH7452-2 1/2"-5X12	TAH111M-34, 36, 50 mm	TAH2484-30 300 mm
TAH7452-7-5x12-13, 17, 19 mm	TAH1177-SCRIBE 230 mm	TAH3734BM-3, 5, 8 mm
TAH111M-34, 36, 50 mm	TAHBE-8985 Ø + 2 mm	TAH3756BM-4 4 mm
TAH8070 158 mm	TAHBE-8020L 0,5x3x7	TAH7005M-1/4" 5, 5, 6, 7, 8, 9, 10, 11, 12, 13 mm
TAH9072 257 mm	TAHBE-8030 0,6x3,5x7,5	TAH6950 1/4"
TAH920EF2 200 mm	TAHBE-8155 1,2x6,5x125	TAH6956 1/4" 150 mm
TAH1150-1/2HP 150 mm	TAHBE-8280 1,6x8,0x175	TAH6958 1/4" 153 mm
TAH1544 0,03-0,10 mm	TAHBE-8610 PH1x75	TAH6960 1/4" 50 mm
TAH2353F2 1kg 4, 522 mm	TAHBE-8620 PH2x100	TAH6961 1/4" 100 mm
TAH2101G-160 160 mm	TAHBE-8630 PH3x150	TAH6962 1/4" 355 mm
TAH2427G-200 200 mm	TAHBE-8810 PZ1x75	TAH6966 1/4" 35 mm
TAH2430G-200 200 mm	TAHBE-8820 PZ2x100	MTS-5-25 25 mm
TAH2628G-160 160 mm	TAHBE-8830 PZ3x150	TAH168 1/2" 10, 11, 12, 13, 14, 15, 16, 17, 18, 19, 21, 22, 24, 27, 30, 32 mm
TAHSC140G 145 mm	TAHBE-8940S 1,0x5,5x125	TAH1610 1/2" 5, 6, 7, 8, 10, 12, 14, 17, 19 mm
TAH2509 525 mm	BTAE-8620S PH2x100	TAH16 1/2" T40, T45, T50, T55, T60
TAH8224 250 mm	TAH810S PH1x80	TAH150-1/2" 1/2"
TAH2047-0,8-4 0,8x4x100	TAH820S PH2x100	TAH158B-1 1/2" 390 mm
TAH2047PR-1 2 PH 1-2	TAH111M-6, 7, 8, 9, 10, 11, 12, 13, 14, 15, 16 mm	TAH160 1/2" 125 mm
TAH111M-6, 7, 8, 9, 10, 11, 12, 13, 14, 15, 16 mm	TAH111M-17 mm	TAH162 1/2" 250 mm
		TAH166 1/2" 72 mm

FUNKENFREIE WERKZEUGE



Funkenfreie Werkzeuge werden in Bereichen eingesetzt, in denen brennbare oder leicht entzündbare Dämpfe, Flüssigkeiten oder Stäube gegeben sind, sowie in Umgebungen, in denen Feuer- und Explosionsgefahr besteht.

Funkenfreie Werkzeuge von Bahco sind gefertigt aus Aluminiumbronze oder Berylliumkupfer, die das Risiko der Entstehung von zündfähigen Funken stark verringern.



Schlosserhammer, funkenfrei

- Fiberglas-Stiel
- Aluminiumbronze
- DIN 1041

BAHCO	↔ mm	∅ mm	g	g	€
NS504-100-FB	280	16	100	220	45,95
NS504-200-FB	280	22	200	320	45,95
NS504-300-FB	280	23	300	420	49,00
NS504-500-FB	310	28	500	700	51,90
NS504-800-FB	340	32	800	1030	95,30
NS504-1000-FB	960	50	1000	2170	95,30
NS504-1500-FB	400	40	1500	1850	146,00
NS504-2000-FB	395	45	2000	2270	189,00

NS408-250



Wasserpumpenzange mit Gleitgelenk, funkenfrei

- Aluminiumbronze
- ISO 8976

BAHCO	max. mm	↔ mm	g	€
NS408-250	45	250	400	144,30

Ring-Maulschlüssel, funkenfrei

- Aluminiumbronze
- DIN 3113

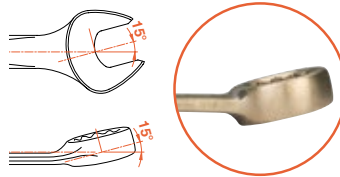

BAHCO	mm	mm	g	€
NS002-6	6	105	16	18,20
NS002-7	7	120	30	20,40
NS002-8	8	120	40	23,10
NS002-9	9	135	42	26,50
NS002-10	10	135	42	28,65
NS002-11	11	150	60	30,75
NS002-12	12	150	60	33,25
NS002-13	13	175	82	34,50
NS002-14	14	175	82	34,95
NS002-15	15	195	140	36,70
NS002-16	16	195	125	38,80
NS002-17	17	195	130	40,10
NS002-18	18	215	165	41,85
NS002-19	19	215	165	42,70
NS002-20	20	215	165	45,75
NS002-21	21	245	260	50,15
NS002-22	22	245	250	52,35
NS002-23	23	265	310	56,95
NS002-24	24	265	290	61,20
NS002-25	25	265	280	68,70
NS002-26	26	290	430	76,20
NS002-27	27	290	410	87,50
NS002-28	28	290	410	97,50
NS002-29	29	320	635	100,20
NS002-30	30	320	580	106,30
NS002-31	31	340	710	133,40
NS002-32	32	340	690	144,95
NS002-33	33	340	690	144,95
NS002-34	34	360	860	144,95
NS002-35	35	360	910	150,40
NS002-36	36	360	880	154,90
NS002-38	38	430	1310	177,75
NS002-40	40	430	1190	200,60
NS002-41	41	430	1230	205,00
NS002-42	42	430	1150	227,90
NS002-46	46	480	1590	227,90
NS002-50	50	520	1830	264,35
NS002-52	52	520	1830	273,50
NS002-55	55	560	2270	282,60
NS002-60	60	595	2640	309,90
NS002-65	65	595	3110	355,50
NS002-70	70	630	3730	391,95
NS002-75	75	630	3620	501,40
NS002-80	80	660	4880	592,60



Rollgabelschlüssel, funkenfrei

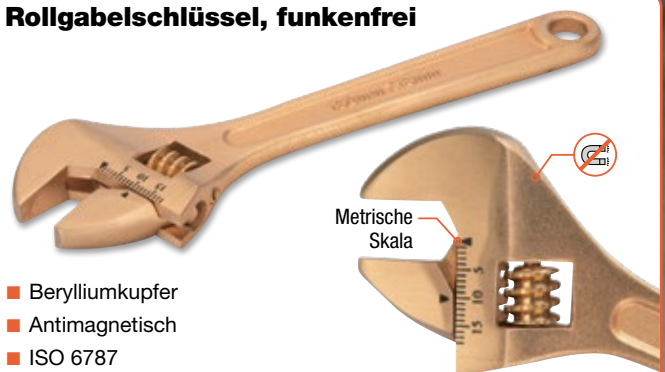

- Berylliumkupfer
- Antimagnetisch
- ISO 6787

BAHCO	mm	mm	g	€
NSB001-150	18	150	135	102,80
NSB001-200	24	200	290	121,40
NSB001-250	30	250	500	146,75
NSB001-300	36	300	830	205,70
NSB001-375	48	375	1550	331,80
NSB001-450	55	450	2261	451,80
NSB001-600	65	600	4990	813,20
NSB001-900	75	900	10000	1.708,00

ERGO™ Schraubendreher für Phillips-Schrauben, funkenfrei



- Aluminiumbronze
- ISO 8764



BAHCO	mm	mm	mm	€
NS302-0-50	⊕ PH 0 x 50	20 x 122	170	32,20
NS302-1-100	⊕ PH 1 x 100	20 x 122	220	36,95
NS302-2-125	⊕ PH 2 x 125	27 x 122	250	39,85
NS302-3-150	⊕ PH 3 x 150	36 x 122	270	45,95
NS302-4-300	⊕ PH 4 x 300	36 x 122	320	71,10

ISOLIERTE WERKZEUGSÄTZE

Alle isolierten Werkzeuge von Bahco werden nach internationalen Normen gemäss IEC 60900 zur Arbeit an spannungsführenden Systemen mit bis zu 1000 V AC und 1500 V DC gefertigt. Sie unterliegen strengen Qualitätskontrollen und werden schärfsten Prüfungen unterzogen.

IEC 60900 1000 V

- ▶ Hohe Leistung und hochwertiges Material
- ▶ Keine Ausbreitung von Flammen
- ▶ Einsatzbereich: -20 C bis +70 C

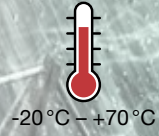

Schwarze Spitze schützt vor Stößen



- = Sicherheit
- = Gefahr
- = hohe Gefahr

Um die Sicherheit bei Arbeiten an spannungsführenden Teilen zu gewährleisten, wird jedes Werkzeug 10 Sekunden lang unter 10.000 Volt getestet.

6MV/10T Einmaulschlüssel-Satz mit Tauchisolierung

IEC 60900 1000 V

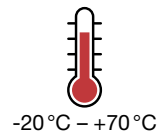

3-fache Tauchisolierung



mm 10 11 12 13 14 16 17 18 19 22

242,95 €



IEC 60900 1000 V



7811DMV
Isolierter Steckschlüssel-Satz

1/2"

- 3-fache Tauchisolierung*
- Stoßfester Kunststoffkoffer

369,00 €

320 x 300 x 100 mm



-20°C – +70°C

11

10 11 13 17 19 20 22 *	
1/2" Umschaltknarre*	
1/2" T-Griff*	
1/2" Verlängerung*	
1.0 x 5.5 x 125	

IEC 60900 1000 V



3045V-2
Elektriker-Werkzeugsatz, isoliert

1/2"

- 3-fache Tauchisolierung*
- Widerstandsfähige Ledertasche mit Metallverstärkungen

369,00 €

430 x 260 x 160 mm



-20°C – +70°C

19

Seitenschneider* 160 mm	
Kombizange* 180 mm	
Flachrundzange* 160 mm	
Abisolierzange* 160 mm	
Einmaulschlüssel* 10 11 12 13 14 17 19 mm	
0.5x3.0 1.0x5.5 0.8x4.0 1.2x6.5	
PH1 PH2	
Elektriker-messer*	
Elektriker-schere	

ISOLIERTE 1000 V SCHRAUBENDREHER

Isolierte ERGO™ Schraubendreher für Schlitzschrauben



⚡ 1000 V ⚡

■ Nach IEC 900, DIN EN 60900, VDE 0682 Teil 201



BAHCO	mm	mm	mm	€
BE-8010S	⊖ 0.4 x 2.5 x 75	20 x 122	197	5,65
BE-8220S	⊖ 0.5 x 3.0 x 100	20 x 122	222	5,85
BE-8230S	⊖ 0.6 x 3.5 x 100	20 x 122	222	6,05
BE-8040S	⊖ 0.8 x 4.0 x 100	20 x 122	222	7,40
BE-8050S	⊖ 1.0 x 5.5 x 125	27 x 122	247	8,75
BE-8065S	⊖ 1.2 x 8.0 x 175	36 x 122	297	14,45

Isolierte ERGO™ Schraubendreher für Phillips® Schrauben



⚡ 1000 V ⚡

■ Nach IEC 900, DIN EN 60900, VDE 0682 Teil 201

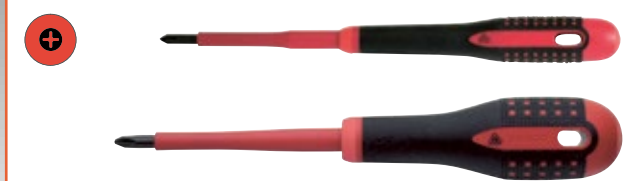

BAHCO	mm	mm	mm	€
BE-8600S	⊕ PH 0 x 75	20 x 122	197	6,45
BE-8610S	⊕ PH 1 x 80	27 x 122	202	7,90
BE-8620S	⊕ PH 2 x 100	36 x 122	222	10,65
BE-8630S	⊕ PH 3 x 150	36 x 122	272	14,75



BE-9881SL ERGO™ Schraubendreher-Satz mit schmalen Klingen, isoliert

ergo® ⚡ 1000 V ⚡

■ Nach IEC 900, DIN EN 60900, VDE 0682 Teil 201

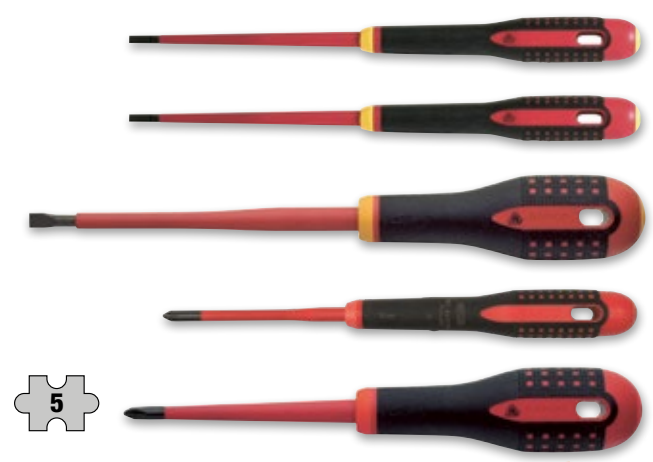

⊖ 0.5 x 3.0 mm 1.0 x 5.5 mm
0.8 x 4.0 mm

⊕ PH1
⊕ PH2

19,95 €

Isolierte ERGO™ Schraubendreher für Pozidriv® Schrauben



⚡ 1000 V ⚡

■ Nach IEC 900, DIN EN 60900, VDE 0682 Teil 201

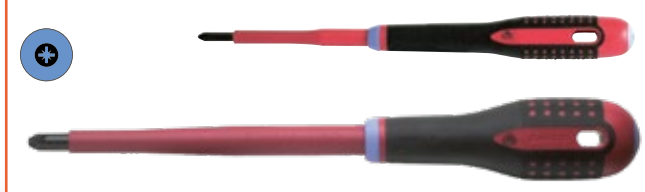

BAHCO	mm	mm	mm	€
BE-8810S	⊕ PZ 1 x 80	27 x 122	202	8,55
BE-8820S	⊕ PZ 2 x 100	36 x 122	222	11,45
BE-8830S	⊕ PZ 3 x 150	36 x 122	272	16,10

Isolierte ERGO™ Schraubendreher für Torx® Schrauben



⚡ 1000 V ⚡

■ Nach IEC 900, DIN EN 60900, VDE 0682 Teil 201



BAHCO	mm	mm	mm	€
BE-8908S	⊗ T 8 x 75	20 x 122	197	7,15
BE-8909S	⊗ T 9 x 75	20 x 122	197	7,15
BE-8910S	⊗ T 10 x 100	20 x 122	222	6,65
BE-8915S	⊗ T 15 x 125	27 x 122	247	6,80
BE-8920S	⊗ T 20 x 125	27 x 122	247	6,95
BE-8925S	⊗ T 25 x 150	27 x 122	272	7,15

BE-9876S
ERGO™ Schraubendreher-Satz
XXL, isoliert

ergo® 1000 V

14

38,50 €



- Nach IEC 900, DIN EN 60900, VDE 0682 Teil 201
- Ergonomische 3-Komponenten-Griffe



Kombispitze
 PZ1-Schlitz 5 mm
 PZ2-Schlitz 6 mm



PZ1
 PZ2



PH1
 PH2



T10
 T15
 T20



0.4x2.5 mm 0.8x4.0 mm
 0.5x3.0 mm 1.0x5.5 mm
 0.6x3.5 mm



30 % schmaler
 als herkömmliche Klingen

Isolierte Ratschenschraubendrehergriffe mit 6 wechselbaren Klingen im Set



- Ratschenmechanismus mit 48 Zähnen für schnelles Festziehen
- Inklusive praktischer Tasche mit 6 Klingen und Gürtelschleufe



Nicht leitende Abdeckung, schneller Klingenwechsel durch Einrastsystem

1000 V

Bahco Design: weicher rutschfester Griff für komfortablen Halt

Patentiert: Druckknopf zum Auslösen der Klingen

808061



808062



BAHCO						€
808061	⊖	0.4x2.5	0.5x3.0	0.8x4.0	1.0x5.5	79,95
	⊕	PH1	PH2			
808062	⊖	0.4x2.5	0.5x3.0	0.8x4.0	1.0x5.5	79,95
	⊕	PZ1	PZ2			

7

7

DREHMOMENT- WERKZEUGE

74WR- Drehmomentschlüssel, auslösend, mit Doppelskala

- Robuster und präziser Mechanismus – nach über 100.000 Zyklen innerhalb von $\pm 3\%$ Toleranz
- Fester Knarrenkopf

Gut lesbare Doppelskala

Hör- und fühlbares Klicksystem

Markierung der Griffmitte für optimalen Griff



Resistent:
Benzin, Öl, Fett



BAHCO	Nm	□	mm	g	€
74WR-15	3–15	1/4"	221	300	109,00
74WR-25	5–25	1/4"	221	300	109,00

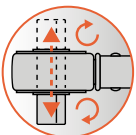

- Durchsteck-Vierkant zum Wechsel der Drehrichtung



BAHCO	Nm	ft.lb	□	mm	g	€
74WR-50	10–50	7.5–37.5	3/8"	335	700	109,00
74WR-100	20–100	15–75	1/2"	387	900	112,00
74WR-200	40–200	30–150	1/2"	470	1100	115,00
74WR-300	60–300	45–220	1/2"	593	1400	125,00
74WR-340	60–340	45–250	1/2"	685	1500	125,00
74WR-400	80–400	60–300	3/4"	686	1900	199,00

Komfortable griffige Oberfläche



Resistent:
Benzin, Öl, Fett



Drehmoment Einstellknopf, deutlich sichtbar in gelöstem Zustand

74PR- Drehmomentschlüssel mit voreinstellbarem Auslösewert

- Robuster und präziser Mechanismus – nach über 100.000 Zyklen innerhalb von $\pm 3\%$ Toleranz
- Fester Knarrenkopf



BAHCO	Nm	mm	mm	g	€
74PR-20	4–20	1/4"	219	400	109,00



Hör- und fühlbares Klicksystem



BAHCO	Nm	mm	mm	g	€
74PR-60	12–60	3/8"	295	600	109,00
74PR-60A	12–60	1/2"	301	700	109,00
74PR-100	20–100	3/8"	335	700	115,00
74PR-100A	20–100	1/2"	342	700	115,00

BAHCO	Nm	mm	mm	g	€
74PR-200	40–200	1/2"	425	1000	125,00
74PR-300	60–300	1/2"	668	1200	129,00
74PR-400	80–400	3/4"	675	2000	149,00

75R3- Drehmomentschlüssel, auslösend, ohne Messwertverschiebung

- Gleichbleibendes Drehmoment bei allen Hebellängen
- Verlängerungsgriff verringert deutlich den Kraftaufwand bei hohen Drehmomenten
- Fester Knarrenkopf

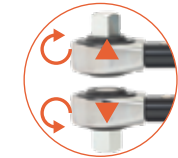

Durchsteck-Vierkant zum Wechsel der Drehrichtung

Hör- und fühlbares Klicksystem



Robustes Metallgehäuse



BAHCO	Nm	mm	mm	g	€
75R3-650*	130–650	3/4"	856	4000	749,00
75R3-800	200–800	3/4"	1037	5200	829,00
75R3-1000	300–1000	3/4"	1245	5800	899,00

* Verlängerungsgriff nicht im Lieferumfang, optional lieferbar



DREHMOMENT- WERKZEUGE

Elektronische Drehmoment-Drehwinkelschlüssel

- Programmierbare Abschaltautomatik
- Daten und Sollwertspeicherung während des Batteriewechsels



- Fester Knarrenkopf mit Gelenk, 40 Zähne

- Beidseitig fortlaufende LEDs



- Vorwarnschwelle erreicht
- Im Sollbereich
- Außerhalb des Toleranzbereichs



- ◆ Nm, Kg.cm., dNm, Lbf.ft., Lbf.in.



Griffvibration

TAW- Elektronische Drehmoment-Drehwinkelschlüssel

- 50 Messungen
- 10 Voreinstellungen

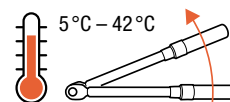

- Arbeitseinstellungen:
 - Drehmoment
 - Drehwinkel
 - Drehmoment dann Drehwinkel
 - voreinstellbare Werte

BAHCO	Nm	□	← mm →	g	€
TAW38135	7-135	3/8"	475	1270	529,00
TAW12340	17-340	1/2"	670	1910	569,00
TAW34800	40-800	3/4"	1235	4850	999,00

TAWM- Elektronische Drehmoment-Drehwinkelschlüssel mit Datenspeicher und USB

- 1500 Messungen
- 50 Voreinstellungen



- Arbeitseinstellungen:
 - Drehmoment
 - Drehwinkel
 - Drehmoment und Drehwinkel
 - Drehmoment dann Drehwinkel
 - voreinstellbare Werte
 - Arbeitsmodus

BAHCO	Nm	□	← mm →	g	€
TAWM38135	7-135	3/8"	475	1280	829,00
TAWM12340	17-340	1/2"	670	1970	889,00
TAWM34800	40-800	3/4"	1235	4850	1.299,00

TAWM1412M/TAWM1430M Elektronische Mikro-Drehmoment-Drehwinkelschlüssel mit Datenspeicher und USB

- 1500 Messungen
- 50 Voreinstellungen



- Arbeitseinstellungen:
 - Drehmoment
 - Drehwinkel
 - Drehmoment und Drehwinkel
 - Drehmoment dann Drehwinkel
 - voreinstellbare Werte
 - Arbeitsmodus

BAHCO	Nm	□	← mm →	g	€
TAWM1412M	0.6-12	1/4"	292	405	699,00
TAWM1430M	1.5-30	1/4"	357	820	699,00

TAS14- Elektronische Drehmoment- & Drehwinkelschraubendreher

- Langlebiges robustes Gehäuse aus Tri-Lobe Verbundmaterial
- Folientastatur mit Tastensperre gegen versehentliches Verstellen
- Arbeitseinstellungen:
 - Drehmoment
 - Drehwinkel
 - Drehmoment dann Drehwinkel



BAHCO	Nm	cNm	□	○	← mm →	mm	g	€
TAS14H09	0.45-9	45-900	-	1/4"	189	40	325	629,00
TAS14S09	0.45-9	45-900	1/4"	-	189	40	325	629,00



89049TM-1000 Mechanischer, handbetätigter Drehmoment-Vervielfältiger

- Austauschbare gerade und abgewinkelte Reaktionsarme

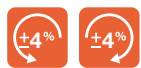
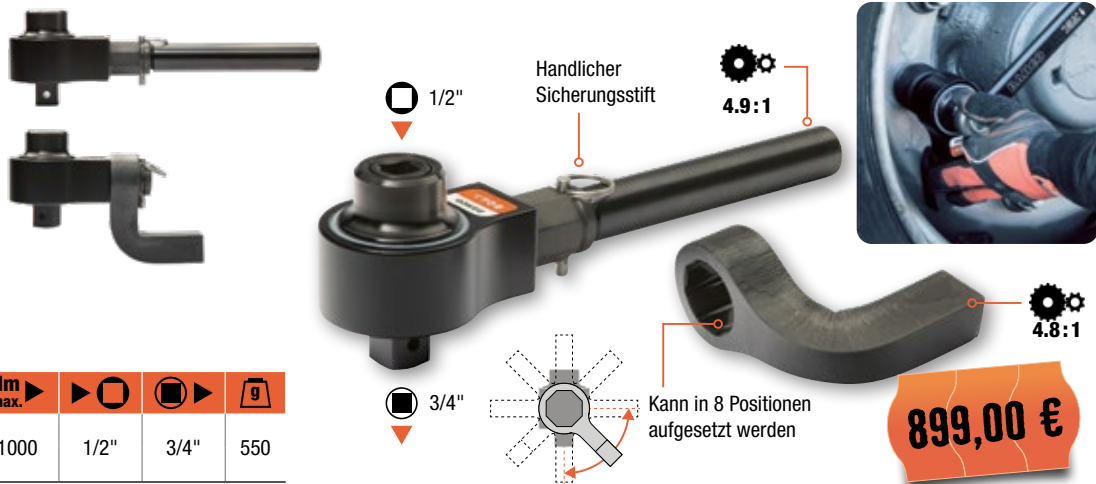

Nm max.	⚙️	Nm max.	▶ □	◻ ▶	g
204	4.9:1	1000	1/2"	3/4"	550
208	4.8:1				

899,00 €

89222CR/96255CR Kompakte, handbetätigte Drehmoment-Vervielfältiger

- Mit abgewinkeltem Reaktionsarm
- Leichte kompakte Bauweise für gute Zugänglichkeit



BAHCO	Nm max.	⚙️	Nm max.	▶ □	◻ ▶	g	€
89222CR-1000	45	22.2:1	1000	1/2"	3/4"	1400	1.795,00
9527CR-2000	74	27:1	2000	1/2"	1"	3200	1.895,00
9525CR-4000	160	25:1	4000	1/2"	1"	5400	3.150,00
96255CR-7000	274	25.5:1	7000	1/2"	1 1/2"	9300	3.750,00

AKKUWERKZEUGE



Metalgehäuse für längere Haltbarkeit und Performance



Alle Sätze im Koffer mit 2 Akkus und Ladegerät

Das neue Sortiment für anspruchsvolle Mechaniker

BCL31IS1K1 Akku Mini-Schlagschrauber-Satz

1/4" | 155 mm

12V | max. 105 Nm

Schnellspannfutter | LED | IP20

0.93 kg

255,00 €

Video BCL31IS1

- Metallgehäuse für längere Haltbarkeit und Performance
- Vibrationsarm dank Zweikomponenten-Griff

Ø	V	Max Nm	min ⁻¹	dba	m/sec ⁻²	mm	kg
1/4"	12	105	0-2400	101.1	8.85	155x50x191	0.93

BCL33IW1K1 Akku Schlagschrauber-Satz

1/2" | 18V

2 Geschwindigkeitsbereiche

110 Nm (550 RPM) + 590 Nm (1650 RPM)

2x | IP20

670,00 €

- Metallgehäuse für längere Haltbarkeit und Performance
- Batterieanzeige bei Betrieb

Ø	V	Max Nm	min ⁻¹	dba	m/sec ⁻²	mm	kg
1/2"	18	105 / 590	550 / 0-1650	99.2	6.65	260x70x258	3.11

BCL31D1K1
Akku Bohrmaschinen-Satz

3/8"-10 mm

12V

Schnellspannfutter

10 Drehmoment-Einstellungen,
1 Bohr-Einstellung

1.03 kg



2 Geschwindigkeitsbereiche

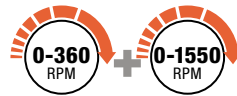

240,00 €



Vibrationsarm dank Zweikomponenten-Griff

	V	Max Nm	min-1	dba	m/sec-2	mm	kg
10	12	24	360 / 1550	83.9	4.00	200x54x191	1.03



BCL32G1K1
Akku Schmierpistolen-Satz

14.4V

367,00 €

750 mm



≥ 400 g
414 bar
70g / min.

V	PSI / BAR	g/min.	dba	m/sec-2	mm	kg
14.4	600 / 414	70	78.6	0.39	200x75x485	3.4

BCL33D1K1
Akku Bohrmaschinen-Satz

1/2"-13 mm

18V

Schnellspannfutter

10 Drehmoment-Einstellungen,
1 Bohr-Einstellung



BÜRSTENLOSE MOTOREINHEIT

- ✓ hohe Drehkraft
- ✓ mehr Schlagzahl
- ✓ weniger Wartung
- ✓ längere Lebenszeit

2 Geschwindigkeitsbereiche



399,00 €

Vibrationsarm dank Zweikomponenten-Griff
Batterieanzeige bei Betrieb

	V	min-1	Max Nm	dba	mm	kg
13	18	0-370 / 0-1570	32	83.5	180x60x290	1.35



AKKUWERKZEUGE

BCL33IW2K1

Akku Schlagschrauber-Satz



1/2"

18V

max. 1000 Nm

HD

IP20



BÜRSTENLOSE MOTOREINHEIT



- ✓ hohe Drehkraft
- ✓ mehr Schlagzahl
- ✓ weniger Wartung
- ✓ längere Lebenszeit



665,00 €

- Hohe Effizienz, überlegene Leistung
- Metallgehäuse für längere Haltbarkeit und Performance

□	V	Max Nm	min ⁻¹	dba	m/sec ⁻²	mm	kg
1/2"	18	1000	0-1700	100.6	6.37	240x65x360	3.1



BCL33AP1K1
Akku Winkelschleifer-Satz

Ø 5"/127 mm Velcro®

18V



519,00 €

- Inklusive Schwamm und Wollhaube zum Reinigen und Polieren
- Mit Sicherheits-Auslöser
- Feststeller für komfortables Arbeiten
- Vibrationsarm dank Zweikomponenten-Griff



mm	V	mm		min-1	dba	m/sec-2	mm	kg
127	18	4.7	5/16" 24UNF	1100-3500	82.5	2.52	376x153	1.82



- 1100
- 1450
- 2300
- 3050
- 3500 rpm



BITSÄTZE UND SCHRAUBENDREHER

59/S54BC Bitsatz

● 1/4" DIN 3126-C6.3, ISO 1173

54



<25mm>							<125mm>	<150mm>
⊖	⊕	⊕	⊕	⊕	⊕	⊕	⊕	⊕
4.5	PH1	PZ1	T10 x2	TR10	HEX3	R1	PH1	T20
5.5	PH2 x4	PZ2 x4	T15 x2	TR15	HEX4	R2	PH2	T25
	PH3	PZ3	T20 x4	TR20	HEX5			T30
	PH2G x2		T25 x2	TR25	HEX6		⊕	
			T27	TR30	HEX8		PZ1	
			T30 x4				PZ2	
			T40					

19,95 €

COLOURED

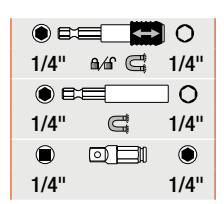
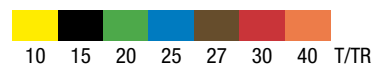

59/S100BC Bitsatz

● 1/4" DIN 3126-C6.3, ISO 1173

100



<25mm>						
⊖	⊕	⊕	⊕	⊕	⊕	⊕
4.5	PH1	PZ1 x2	T10 x3	TR10	HEX3	R1
5.5	PH2 x9	PZ2 x9	T15 x5	TR15	HEX4 x3	R2
	PH3	PZ3	T20 x15	TR20	HEX5	
	PH2G x5		T25 x8	TR25	HEX6 x3	
			T27	TR30	HEX8	
			T30 x15			
			T40 x3			

24,95 €

COLOURED

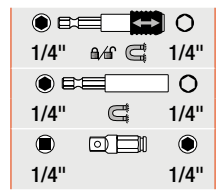
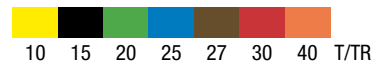

59/S31B Bitsatz

● 1/4" DIN 3126-C6.3, ISO 1173

31

9,95 €



⊖	⊕	⊕	⊕	⊕
4.5	PH1	PZ1	T10	HEX3
5.5	PH2 x3	PZ2 x3	T15 x3	HEX4
	PH3	PZ3	T20 x3	HEX5
	PH2G x2		T25 x2	HEX6
			T27	
			T30	



59S/22-2 Bitsatz

■ Im Gummihalter

22

● 1/4" DIN 3126-C6.3, ISO 1173

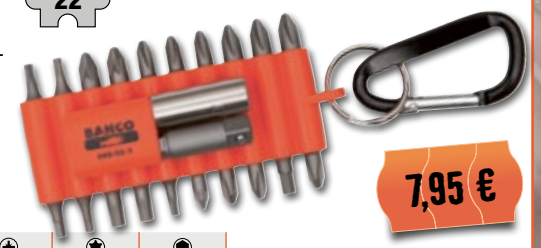

7,95 €

⊕	⊕	⊕	⊕
PH2 x3	PZ2 x2	T10	HEX2.5
PH2G x2	PZ3	T15 x4	HEX3.0
		T20 x3	
		T25 x2	

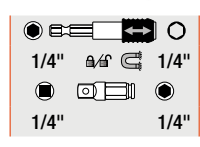



19,95 €

30°

808050P
Bit-Ratschenschraubendreher
mit Pistolengriff

● 1/4" DIN 3126-C6.3, ISO 1173

- Pistolengriff durch Knopfdruck um 30° schwenkbar
- Mit 6 Bits im Magazin

⊖	⊕	⊕
0.6x4.5	PH1	PZ1
0.8x5.5	PH2	PZ2



808050L
Bit-Ratschenschraubendreher
mit LED

● 1/4" DIN 3126-C6.3, ISO 1173

- Mit 6 Bits im Magazin

19,95 €



⊖	⊕	⊕
0.6x4.5	PH1	PZ1
0.8x5.5	PH2	PZ2

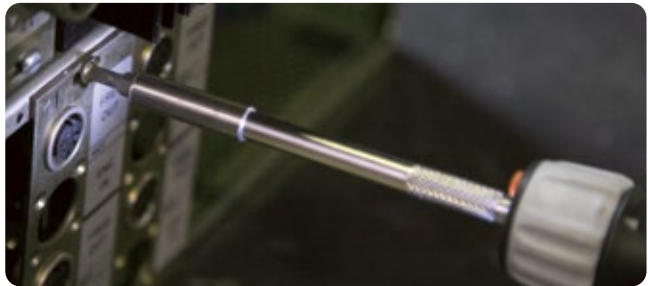

808050S
Bit-Ratschenschraubendreher,
kurz

● 1/4" DIN 3126-C6.3, ISO 1173

- Zum Arbeiten in beengten Bereichen

13,95 €



KM653-QR-1P
Magnetischer Bithalter



4,95 €



○	●
1/4"	1/4"

2058/S26
Bit-Steckschlüssel-
Satz mit Bitnarre

26

20,95 €

- Mit Hilfe der patentierten 1/4" Bitnarre (US Pat. 6860175) lassen sich Schrauben und Muttern in engen Räumen bequem lösen und anziehen.

8 mm 1/4"

⊖	⊕	⊕	⊕	●	○
4.0	PH1	PZ1	T10	3	6
5.0	PH2	PZ2	T15	4	7
6.0	PH3	PZ3	T20	5	8
			T25	6	10
			T30		13

1/4" 1/4" 1/4" 1/4"



SCHRAUBENDREHER

ERGO™ Schraubendreher für Schlitzschrauben



■ BE-8160 mit Sechskant-Ansatz für Schraubenschlüssel zur Kraftverstärkung



BAHCO					€
BE-8010	⊖ 0.4 x 2.5 x 60	20 x 122	182	-	3,00
BE-8030	⊖ 0.6 x 3.5 x 75	20 x 122	197	-	3,95
BE-8040	⊖ 0.8 x 4.0 x 100	20 x 122	222	-	4,40
BE-8150	⊖ 1 x 5.5 x 100	27 x 122	222	-	7,10
BE-8155	⊖ 1.2 x 6.5 x 125	36 x 122	247	-	8,50
BE-8160	⊖ 1.6 x 8 x 125	36 x 122	247	14	13,75

ERGO™ Schraubendreher für Phillips® Schrauben



■ BE-8630 mit Sechskant-Ansatz für Schraubenschlüssel zur Kraftverstärkung

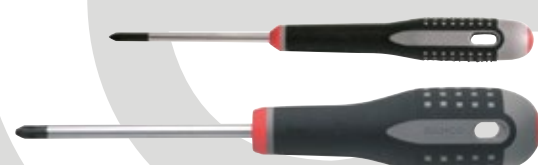

BAHCO					€
BE-8600	⊕ PH 0 x 60	20 x 122	182	-	5,15
BE-8610	⊕ PH 1 x 75	27 x 122	197	-	6,55
BE-8620	⊕ PH 2 x 100	36 x 122	222	-	8,80
BE-8630	⊕ PH 3 x 150	36 x 122	272	14	16,35

ERGO™ Schraubendreher für Pozidriv® Schrauben



■ BE-8830 mit Sechskant-Ansatz für Schraubenschlüssel zur Kraftverstärkung



BAHCO					€
BE-8800	⊕ PZ 0 x 60	20 x 122	182	-	6,30
BE-8810	⊕ PZ 1 x 75	27 x 122	197	-	7,35
BE-8820	⊕ PZ 2 x 100	36 x 122	222	-	9,45
BE-8830	⊕ PZ 3 x 150	36 x 122	272	14	14,25



Ergonomische Schraubendreher Die Pluspunkte liegen in der Hand

- 1 Dauerhafte Farbkodierung zur Wahl des richtigen Klingentyps
- 2 Optimale Grifflänge mit Schnelldrehzone
- 3 Dreikomponentengriff: fester Kern mit griffiger Oberfläche
- 4 Abgerundete Formen zur Vermeidung von Druckpunkten
- 5 Weiche, rutschfeste Oberfläche
- 6 Abgeflacht, um Wegrollen zu verhindern

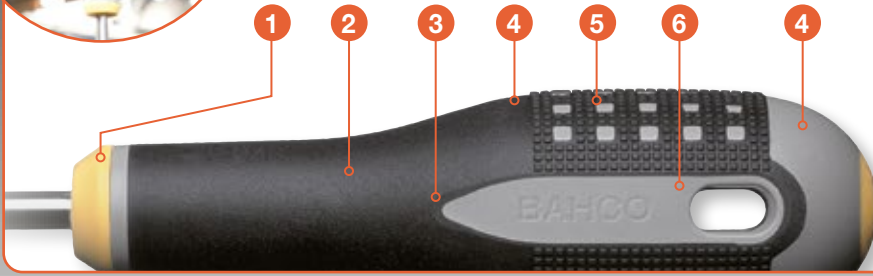

ergo®

ERGO™ Schraubendreher für Innensechskant-Schrauben

ergo®

- Mit Kugelkopf für besseren Zugang



BAHCO	mm	mm	mm	€
BE-8715	● H 1.5 x 60	20 x 122	182	4,25
BE-8702	● H 2 x 100	20 x 122	222	4,35
BE-8725	● H 2.5 x 100	20 x 122	222	4,40
BE-8703	● H 3 x 100	20 x 122	222	4,55
BE-8704	● H 4 x 100	27 x 122	222	5,45
BE-8705	● H 5 x 100	36 x 122	222	6,55
BE-8706	● H 6 x 125	36 x 122	247	7,50
BE-8708	● H 8 x 150	36 x 122	272	10,95

ERGO™ Schraubendreher für Torx® Schrauben

ergo®

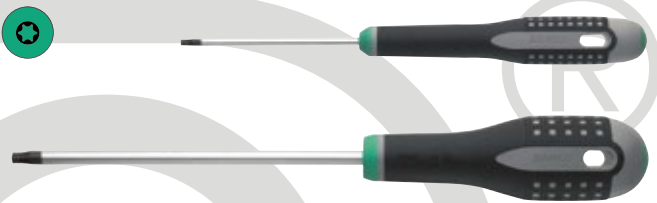

BAHCO	mm	mm	mm	€
BE-8904	⊕ T 4 x 75	20 x 122	197	6,00
BE-8905	⊕ T 5 x 75	20 x 122	197	6,00
BE-8906	⊕ T 6 x 75	20 x 122	197	6,00
BE-8907	⊕ T 7 x 75	20 x 122	197	6,00
BE-8908	⊕ T 8 x 75	20 x 122	197	6,10
BE-8909	⊕ T 9 x 75	20 x 122	197	6,10
BE-8910	⊕ T 10 x 75	20 x 122	197	6,20
BE-8915	⊕ T 15 x 100	27 x 122	222	6,20
BE-8920	⊕ T 20 x 100	27 x 122	222	6,30
BE-8925	⊕ T 25 x 125	27 x 122	247	6,75
BE-8930	⊕ T 30 x 150	36 x 122	272	8,30

ERGO™ Schraubendreher für Torq-Set® Schrauben



ergo®



BAHCO	mm	mm	mm	€
BE-8080-1	⊕ 1 x 75	27 x 122	197	14,35
BE-8080-2	⊕ 2 x 75	27 x 122	197	14,70
BE-8080-3	⊕ 3 x 75	27 x 122	197	14,70
BE-8080-4	⊕ 4 x 75	27 x 122	197	14,70
BE-8080-5	⊕ 5 x 75	27 x 122	197	14,70
BE-8080-6	⊕ 6 x 75	27 x 122	197	14,70
BE-8080-8	⊕ 8 x 100	27 x 122	222	20,40
BE-8080-10	⊕ 10 x 100	27 x 122	222	20,40

BE-3529 ERGO™ O-Ring-Heber

ergo®

- Zum Entlöten



BAHCO	mm	mm	mm	€
BE-3529	3 x 175	20 x 122	175	13,15

SCHRAUBENDREHER

BE-9877 ERGO™ Schraubendreher-Satz XXL

■ Ergonomische 3-Komponenten-Griffe

ergo®

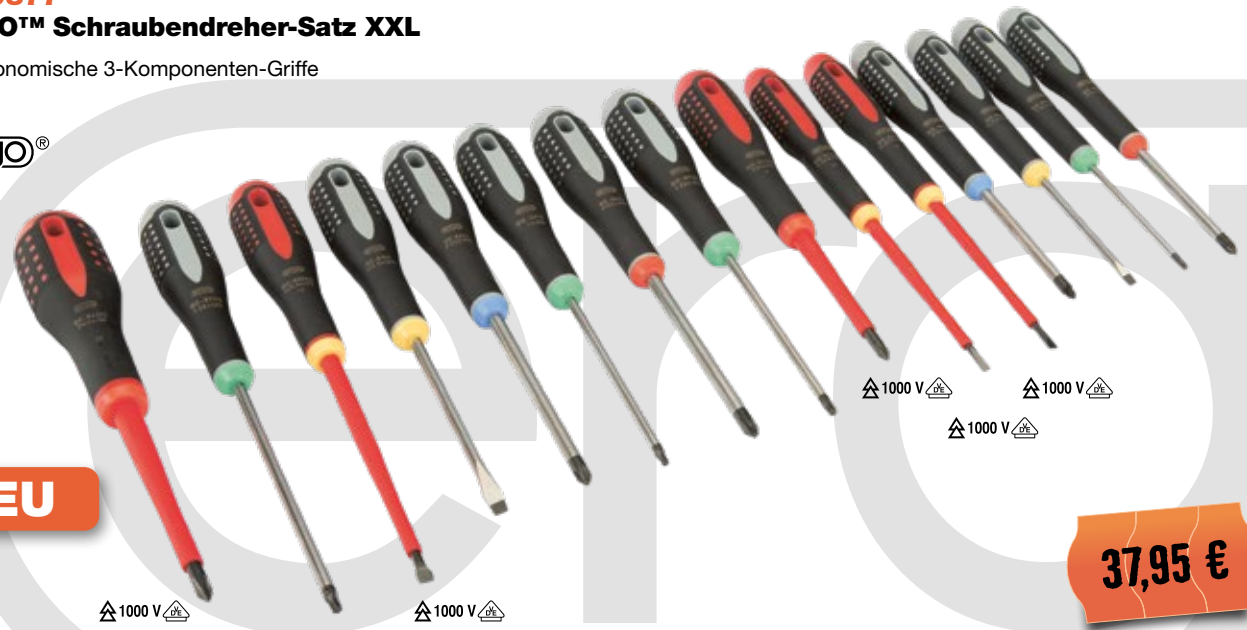

NEU

37,95 €

15

0.6x3.5x75 mm 1.0x5.5x100 mm	PH1 x75 mm PH2 x100 mm	PZ1 x75 mm PZ2 x100 mm	T10x75 mm T15x100 mm T20x100 mm T25x125 mm

Isolierte 1000 V Schraubendreher nach IEC 900, DIN EN 60900, VDE 0682 Teil 201

0.5x3.0x100 mm
0.8x4.0x100 mm
1.0x5.5x125 mm

PH1 x80 mm
PH2 x100 mm

T-Griff Schraubendreher-Sätze



Lange Klinge für eine gute Drehkontrolle, bietet einfachen Zugang zu tiefliegenden Schrauben

Kurze 90° Klinge für hohe Drehkraftübertragung bei Arbeiten mit begrenzter Höhe



6



BAHCO			€	
903T-1		Sechskant	3, 4, 5, 6, 8, 10 mm	54,70
903T-2		TORX®	T10, T15, T20, T25, T30, T40	50,40
903T-3		Steckschlüssel	5, 6, 7, 8, 10, 13 mm	62,50

BE-9881TB
Satz ERGO™ Schraubendreher
mit durchgehender Klinge



0.6x3.5x75
0.8x4.5x100
1.0x5.5x100
1.2x6.5x125



PH1 x100
PH2x125

29,95 €

706-5
Präzisionsschraubendreher-Satz



- Rotierende Endkappe für schnelles Anziehen und Lösen
- Dauerhafte Farbkodierung

⊖	⊕	⊕	⊕	⊕	⊕	⊕
1.0	2.0	PH00	PZ0	T6	T10	M 1.5
1.2	3.0	PH0	PZ1	T7	T15	M 2.0
1.5	3.5	PH1	PZ3	T8	T20	M 2.5
1.8	4.0			T9		M 3.0



133,20 €

Spannungsprüfer bis 250 V



8045LVDE mit Clip

- Schlagfester Kunststoffgriff
- Gemäß DIN VDE 0680/6 GS-geprüft

BAHCO	⊖	mm	€
8045VDE	0.5x3.5	134	8,95
8045LVDE	0.5x3.5	170	8,95

UMSCHALTKNARREN

Umschaltknarren mit schlankem Kopf



6950SL
Umschaltknarre 1/4"

■ 72 Zähne

7750SL
Umschaltknarre 3/8"

■ 72 Zähne

8150SL
Umschaltknarre 1/2"

■ 72 Zähne

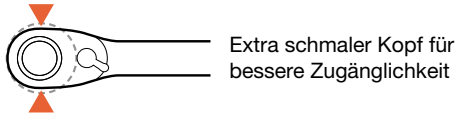

BAHCO	□	∠	← mm →	g	€
6950SL	1/4"	5°	120	90	22,95
7750SL	3/8"	5°	205	200	27,95
8150SL	1/2"	5°	265	440	31,50

Schwenkopf-Knarren



■ 72 Zähne

NEU



BAHCO	□	∠	← mm →	g	€
8120-1/4	1/4"	5°	149	129	17,95
8120-3/8	3/8"	5°	223	311	26,50
8120-1/2	1/2"	5°	266	572	32,95



ERGO™ Einhand-Umschaltknarren



7755-3/8

Umschaltknarre 3/8"

■ 72 Zähne



8155-1/2

Umschaltknarre 1/2"

■ 60 Zähne

BAHCO	□	∠	← mm →	g	€
7755-3/8	3/8"	5°	215	245	47,40
8155-1/2	1/2"	6°	260	575	53,90

STECKSCHLÜSSEL-EINSÄTZE

Verbindungsteile



BAHCO	□	○	←mm→	€
K6650-1/4-1P	1/4"	1/4"	50	8,05
K6650-3/8-1P	3/8"	1/4"	60	6,85
K6650-1/2-1P	1/2"	1/4"	60	8,95

Magnetische Steckschlüssel



BAHCO	○	○	€
KM6750-7	1/4"	7 mm	2,95
KM6750-8	1/4"	8 mm	2,95
KM6750-10	1/4"	10 mm	2,95
KM6750-13	1/4"	13 mm	2,95
KM6750-3/8	1/4"	3/8"	2,95

7400SR/S12 Satz Steckschlüssel-Einsätze

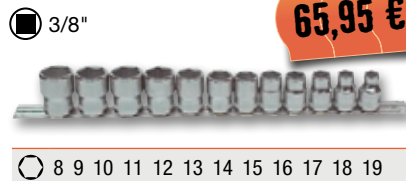

65,95 €

8 9 10 11 12 13 14 15 16 17 18 19

7408MD Satz Steckschlüssel-Einsätze, lang



35,00 €

8 10 11 12 13 14 17 19 | ←mm→ | 60-63

7400TORX-ER/S7 Satz Steckschlüssel-Einsätze



60,40 €

E8 E10 E11 E12 E14 E16 E18

7409MR/S7 Satz Schraubendreher-Einsätze



56,65 €

M3 M4 M5 M6 M7 M8 M10

7409TORX-TRR/S5 Satz Schraubendreher-Einsätze



53,20 €

TR27 TR30 TR40 TR45 TR50

7810MH Satz Steckschlüssel-Einsätze



54,20 €

10 11 13 14 15 16 17 19 21 22

7806MD Satz Steckschlüssel-Einsätze, lang



62,55 €

10 13 14 17 19 22 | ←mm→ | 82.6

7807TE Satz Steckschlüssel-Einsätze



46,10 €

E10 E12 E14 E16 E18 E20 E24

7808HM Satz Schraubendreher-Einsätze



67,90 €

M4 M5 M6 M7 M8 M10 M12 M14

7809TO Satz Schraubendreher-Einsätze



96,95 €

T20 T25 T27 T30 T40 T45 T50 T55 T60

Steckschlüssel-Einsätze auf Klemmleiste:

6713MH Satz Steckschlüssel-Einsätze



53,30 €

4 4.5 5 5.5 6 7 8 9 10 11 12 13 14

6708DMB Satz Steckschlüssel-Einsätze, lang



38,60 €

6 7 8 9 10 11 12 13 | ←mm→ | 50.6

STECKSCHLÜSSEL-SÄTZE



24,00 €

SL25 Steckschlüssel-Satz 25

- 1/4"
- Metrisch
- Hochleistungs-Stahllegierung, matt
- ISO 1174/DIN 3120



Bahco Online-Katalog >



○ 4 4.5 5 5.5 6 7 8 9 10 11 12 13
● 1/4" 60 Zähne, 6° Arbeitswinkel
● 1/4" 100 mm
○ 1/4" 1/4"
⊕ T10 15 20 25 30 40
● M 5 6 ⊕ PH 1 2



24,00 €

SL25AF Steckschlüssel-Satz 25

- 1/4"
- Zoll
- Hochleistungs-Stahllegierung, matt
- ISO 1174/DIN 3120



Bahco Online-Katalog >



○ 1/8" 5/32" 3/16" 7/32" 1/4" 9/32" 5/16" 11/32" 3/8" 7/16" 1/2" 9/16"
● 1/4" 60 Zähne, 6° Arbeitswinkel
● 1/4" 100 mm
○ 1/4" 1/4"
⊕ T10 15 20 25 30 40
● 7/32" 1/4" ⊕ PH 1 2



32,95 €

SL25L Steckschlüssel-Satz 37

- 1/4"
- Metrisch
- Mit extra langen Steckschlüsseln
- Hochleistungs-Stahllegierung, matt
- ISO 1174/DIN 3120



Bahco Online-Katalog >



○ 4 4.5 5 5.5 6 7 8 9 10 11 12 13
○ 4 5 6 7 8 9 10 11 12 13
● 1/4" 60 Zähne, 6° Arbeitswinkel
● 1/4" 100 mm
○ 1/4" 1/4"
⊕ T10 15 20 25 30 40
● M 4 5 6 ⊕ PH2 x 2 ⊕ PZ2 x 2



39,00 €

S330 Steckschlüssel-Satz 34

- 1/4" + 3/8"
- Metrisch
- Hochleistungs-Stahllegierung, matt
- ISO 1174/DIN 3120



Bahco Online-Katalog >



○ 10 11 12 13 14 15 16 17 18 19 20 22
○ 16 21
● 3/8" 60 Zähne, 6° Arbeitswinkel
● 3/8" 75 & 150 mm
● 3/8"
○ 3/8" 1/4"
● 1/4" 1/4"
● 1/4"
⊖ 4 5.5 7
⊕ PH 1 2 3 4
● M 3 4 5 6 7 8





64,00 €

S240 Steckschlüssel-Satz

24

1/2"

- Metrisch
- Hochleistungs-Stahllegierung, matt
- ISO 1174/DIN 3120



Bahco Online-Katalog >



10 11 12 13 14 15 16 17 18 19 20 21 22 23 24 27 30 32
1/2" 60 Zähne, 6° Arbeitswinkel
1/2" 250 mm
1/2" 125 & 150 mm
1/2" &



64,00 €

S240AF Steckschlüssel-Satz

24

1/2"

- Metrisch + Zoll
- Hochleistungs-Stahllegierung, matt
- ISO 1174/DIN 3120



Bahco Online-Katalog >



1/8" 3/8" 7/16" 1/2" 9/16" 5/8" 11/16" 3/4" 13/16" 7/8" 15/16" 1" 1.1/16" 1.1/8" 1.3/16" 1.1/4"
5/8" (16 mm) & 13/16" (21 mm)
1/2" 60 Zähne, 6° Arbeitswinkel
1/2" 250 mm
1/2" 125 & 150 mm
1/2" &



67,00 €

S330L Steckschlüssel-Satz

53

1/4" + 3/8"

- Metrisch
- ISO 1174/DIN 3120
- Mit extra langen Steckschlüsseln
- Hochleistungs-Stahllegierung, matt



Bahco Online-Katalog >



10 11 12 13 14 15 16 17 18 19 20 22
10 11 12 13 14 15 17 18 19 20 22
16 21
3/8" 60 Zähne, 6° Arbeitswinkel
3/8" 75 & 150 mm
3/8" &
3/8" 1/4"
1/4" 1/4"
1/4" &
4 5.5 7
PH 1 2 3 PZ 1 2
M 2.5 3 4 5 6 7 8
T10 T15 T20 T25 T30 T40



87,00 €

S560 Steckschlüssel-Satz

56

1/4" + 1/2"

- Metrisch
- ISO 1174/DIN 3120
- Mit Doppelsechskant-Steckschlüsseln
- Hochleistungs-Stahllegierung, matt



Bahco Online-Katalog >



4 4.5 5 5.5 6 7 8 9 10 11 12 13
4 5 6 7 8 9 10 11 12 13
1/4" 72 Zähne, 5° Arbeitswinkel
1/4" &
1/4" 50 & 100 mm
1/4" &
10 11 12 13 14 15 17 19 22 24 27 1/2" 30 32
16 21
1/2" 72 Zähne, 5° Arbeitswinkel
1/2" 250 mm
1/2" 125 & 150 mm
1/2" &
1/2" 5/16"
1/4" 1/4"
1/4" 1/4"
5/16" T45 T50 T55
1.5 2 2.5

STECKSCHLÜSSEL-SÄTZE



S18HEX
Schraubendreher-Einsätze

18

1/2" Sechskant

- Hochleistungs-Stahllegierung, matt
- ISO 1174/DIN 3120

NEU **69,95 €**

● M 4 5 6 7 8 10 12 14 17	←mm→ 60
● M 4 5 6 7 8 10 12 14 17	←mm→ 130



S9HEX
Schraubendreher-Einsätze

9

1/2" Sechskant

- Hochleistungs-Stahllegierung, matt
- ISO 1174/DIN 3120

● M 4 5 6 7 8 10 12 14 17



S18TORX
Schraubendreher-Einsätze

18

1/2" TORX®

- Hochleistungs-Stahllegierung, matt
- ISO 1174/DIN 3120

NEU **57,95 €**

● T20 T25 T27 T30 T40 T45	←mm→ 60
● T20 T25 T27 T30 T40 T45	←mm→ 130



S9TORX
Schraubendreher-Einsätze

9

1/2" TORX®

- Hochleistungs-Stahllegierung, matt
- ISO 1174/DIN 3120

● T20 T25 T27 T30 T40 T45 T50 T55 T60



SW79
Schwenkkopf-Knarren-Satz

79

1/4" + 1/2"

- Metrisch
- Hochleistungs-Stahllegierung, matt
- ISO 1174/DIN 3120

NEU

109,00 €



○ 1/4"	4 4.5 5 5.5 6 7 8 10 11 12 13
● 1/4"	Schwenkkopf-Knarre
● 1/4"	
● 1/4"	75 & 150 mm
○ 1/2"	10 11 12 13 15 16 17 18 19 21 22 23 24 27
● 1/2"	Schwenkkopf-Knarre
● 1/2"	125 & 250 mm
○ 3/8"	1/2"
○ 1/4"	1/4"
⊕	PH1 PH2
⊕	PZ1 PZ2
●	T10 T15 T20 T25 T27 T30
●	M 3 4 5 6
● 1/4"	1/4" 1/4" 1/4" 1/4"
⊖	SL 3.0, 4.5, 5.5
⊕	1xPH1, 4xPH2, 1xPH3, 2xPH2G
⊕	1xPZ1, 4xPZ2, 1xPZ3
●	1xT10, 2xT15, 2xT20, 1xT25, 1xT27, 2xT30
●	M 3 4 5 6



139,95 €

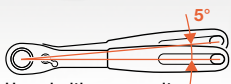

Umschaltknarren mit schmalen Kopf und 72 Zähnen

S95 Steckschlüssel-Satz



1/4" + 1/2"

- Metrisch
- Hochleistungs-Stahllegierung, matt
- ISO 1174

NEU



Bahco Online-Katalog >



1/4"	4 4.5 5.5 6 7 8 9 10 11 12 13
1/4"	72 Zähne, 5° Arbeitswinkel
1/4"	
1/4"	75 & 150 mm
1/4"	&
1/2"	10 11 12 13 14 15 17 18 19 20 21 22 24 27 30 32
1/2"	16 21
1/2"	72 Zähne, 5° Arbeitswinkel
1/2"	125 & 150 mm
1/2"	&
1.5 2 2.5 3 4 5 6 8 10	
7, 8, 9, 10, 11, 12, 13, 14, 15, 16, 17, 18, 19	
1/4"	1/4" 1/4" 1/4"
4.5 5.5	
PH1 PH2 PH2 PH2 PH3 PH2G PH2G	
PZ1 PZ2 PZ2 PZ3	
T10 T15 T15 T20 T20 T25 T25 T27 T30	
M 3 4 5 6	



139,00 €

S106 Steckschlüssel-Satz



1/4" + 1/2"

- Metrisch + Zoll
- Hochleistungs-Stahllegierung, matt
- ISO 1174/DIN 3120



Bahco Online-Katalog >



1/4"	4 4.5 5.5 6 7 8 9 10 11 12 13
1/4"	4 5 6 7 8 9 10 11 12 13
1/4"	60 Zähne, 6° Arbeitswinkel
1/4"	
1/4"	75 & 150 mm
1/4"	&
1/2"	10 11 12 13 14 15 17 19 20 22 24 27 30 32
1/2"	3/8" 7/16" 1/2" 9/16" 11/16" 3/4" 13/16" 7/8" 1/2" 1.3/16"
1/2"	16 21
1/2"	17 19 21 24
1/2"	60 Zähne, 6° Arbeitswinkel
1/2"	250 mm
1/2"	125 & 150 mm
1/2"	&
1/4"	1/4"
1/4"	1/4"
4 5.5 7	
PH 1 2 3 4	
M 3 4 5 6 7 8	
1.5 2 2.5	
8 9 10 11 12 13 14 15 17 19 21 24 27	
8-9 10-11 12-13 14-15	



195,00 €

SLX 17 Steckschlüssel-Satz



3/4"

- Metrisch
- Hochleistungs-Stahllegierung, matt
- ISO 1174/DIN 3120

Bahco Online-Katalog >



22 24 27 30 32 33 34 36 38 41 46 50
3/4"
3/4"
500 - 815 mm
200
400
3/4"



- Koffer aus stoßfestem, öl- und temperaturbeständigem HDPE

KRAFTSTECK- SCHLÜSSELSÄTZE



D/S10
Kraftsteckschlüssel-
Satz

10

1/2"

- Hochleistungs-Stahllegierung, brüniert
- DIN 3129, ISO 2725



DYNAMIC-DRIVE™

43,05 €

○ 10 11 12 13 14 15 16 17 18 19	←mm→ 38
⊕ x2	



D/S14
Kraftsteckschlüssel-
Satz

14

1/2"

- Hochleistungs-Stahllegierung, brüniert
- DIN 3129, ISO 2725



DYNAMIC-DRIVE™

58,00 €

○ 10 11 12 13 14 15 16 17 18 19	←mm→ 38
○ 20 21 22	
○ 24 27	←mm→ 45
⊕ x1	



DD/S10
Kraftsteckschlüssel-
Satz, lange Ausführung

10

1/2"

- Hochleistungs-Stahllegierung, brüniert
- DIN 3129, ISO 2725



DYNAMIC-DRIVE™

59,00 €

○ 10 11 12 13 14 15 16 17 18 19	←mm→ 80
---------------------------------	---------



DD/S14
Kraftsteckschlüssel-
Satz, lange Ausführung

14

1/2"

- Hochleistungs-Stahllegierung, brüniert
- DIN 3129, ISO 2725



DYNAMIC-DRIVE™

97,00 €

○ 10 11 12 13 14 15 16 17 18	←mm→ 80
○ 19 20 21	
○ 22 24 27	←mm→ 88
⊕ x3	



D-DD/S20
Kraftsteckschlüssel-
Satz

20

1/2"

- Hochleistungs-Stahllegierung, brüniert
- DIN 3129, ISO 2725



DYNAMIC-DRIVE™

94,00 €

○ 10 11 12 13 14 15 16 17	←mm→ 38
○ 18 19	
○ 10 11 12 13 14 15 16 17	←mm→ 80
○ 18 19	
⊕ x3	

DURCHSTECK- STECK- SCHLÜSSEL



209,00 €

K8901M/8 Kraftsteckschlüssel- Satz



3/4"

- Hochleistungs-Stahllegierung, brüniert
- DIN 3129, ISO 2725



21 22 24 27 30 32 36 41 | <mm> 51-58



325,00 €

K8906M/8 Kraftsteckschlüssel- Satz, lange Ausführung



3/4"

- Hochleistungs-Stahllegierung, brüniert
- DIN 3129, ISO 2725



21 22 24 27 30 32 36 41 | <mm> 95-100



Mit Umschalthebel

5°

- Durchsteck-Knarre für lange Gewinde, 3/8" (19 mm)
- 72 Zähne
- Mit flexiblem Kopf für bessere Zugänglichkeit



49,50 €

S140T Durchsteck- Steckschlüssel-Satz



- Hochleistungs-Stahllegierung, matt
- DIN 3120, ISO 1174

10 11 12 13 14 15 16 17 19 21 22 24
3/8" 72 Zähne
3/8" 3/8" <mm> 75



- Koffer aus stoßfestem, öl- und temperaturbeständigem HDPE



89,00 €

S530T Durchsteck- Steckschlüssel-Satz



- Hochleistungs-Stahllegierung, matt
- DIN 3120, ISO 1174

10 11 12 13 14 15 16 17 19 21 22 24
8 9 10 11 12 13 14 15 16 17
E8 E10 E11 E12 E14 E16 E18 E20 E22
3/8" 72 Zähne
3/8" 3/8" <mm> 75
3/8" 1/4" & 3/8" & 1/2"
3/8" 1/4" & 5/16"
5/16" M 7 8 10 12 mm
5/16" TTX 40H 45H 50H 55H
1/4" M 5 6 mm
1/4" TTX 20H 25H 27H 30H

SCHRAUBEN-SCHLÜSSEL

Ring-Maulschlüssel-Sätze

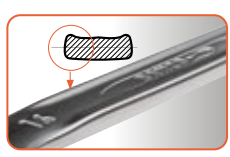

U-förmiger Schaft mit breiter Auflagefläche

Dickes Ringende mit geringem Durchmesser

■ ISO 691 / ISO 7738 / ISO 3318 / ISO 1711-1 / DIN 3113

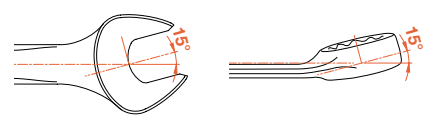

In Kunststoff-Rolltasche, metrisch



66,85 €

111M/11T
8 9 10 11 12 13 14 15
17 19 22 mm



120,00 €

111M/14T
6 8 9 10 13 14 15 17 19 22
24 27 30 32 mm



234,60 €

111M/26T
6 7 8 9 10 11 12 13 14 15 16 17 18 19
20 21 22 23 24 25 26 27 28 29 30 32 mm

Zoll-Abmessungen



95,00 €

111Z/11T
3/8" 7/16" 1/2" 9/16"
5/8" 11/16" 3/4" 13/16"
7/8" 15/16" 1"

In Kunststoffhalter, metrisch

- mit Gürtelclip
- leichte Identifikation



70,00 €

111M/SH12
8 9 10 11 12 13 14
15 16 17 18 19 mm





6M/10C
Doppelmaulschlüssel-Satz

ISO 691 / ISO 1085 / ISO 10102 / ISO 3318

10

52,40 €

6x7 8x9 10x11 12x13 14x15 16x17 18x19 20x22 24x27 30x32 mm

S20/SH12
Ringmaulschlüssel-Satz, S-Serie

DYNAMIC-DRIVE™

12

49,00 €

6 7 8 9 10 11 12 13 14 15 17 19 22 mm

1936M/7
Doppel-Steckschlüssel-Satz

DIN 896-B
Aus Rohr, gerade

25,00 €

Inhalt:
8x9 10x11 12x13 14x15 16x17 18x19 20x22 mm,
2 Stufen-Drehstifte 6-10 und 12-16 mm

Verstellbare Hakenschlüssel

Gelenkkopf mit Haken für verschiedene Durchmesser von Ringen und Lagern

BAHCO	mm	mm	g	€
4106-19-50	19-50	158	130	14,45
4106-20-35	20-35	165	185	22,30
4106-32-75	32-75	203	240	24,00
4106-35-60	35-60	210	170	24,30
4106-60-90	60-90	280	360	32,15
4106-90-155	90-155	335	610	36,50
4106-155-230	155-230	460	1200	71,50

KNARRENSCHLÜSSEL

Knarren-Ring-Maulschlüssel

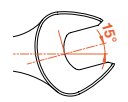
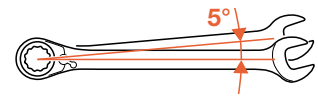

■ ISO 1711-1 / DIN 3113

- Hochleistungs-Stahllegierung
- Verchromte Micro-Matt-Ausführung mit hochwertiger Oberfläche

BAHCO	mm	mm	g	€
1RM-6	6	128	27	9,00
1RM-7	7	140	35	9,00
1RM-8	8	140	38	9,00
1RM-9	9	150	48	9,50
1RM-10	10	159	59	10,00
1RM-11	11	165	67	10,10
1RM-12	12	172	82	10,70
1RM-13	13	178	95	10,95
1RM-14	14	191	113	11,40
1RM-15	15	200	130	12,15

BAHCO	mm	mm	g	€
1RM-16	16	208	158	12,95
1RM-17	17	226	180	13,95
1RM-18	18	237	213	14,20
1RM-19	19	248	233	14,50
1RM-21	21	290	343	23,20
1RM-22	22	290	343	19,75
1RM-24	24	323	503	23,50
1RM-27	27	359	550	38,60
1RM-30	30	393	750	45,40
1RM-32	32	425	900	51,50

Knarren-Ring-Maulschlüssel-Sätze, metrisch

Zoll-Abmessungen

67,65 €

1RM/SH6

8 10 12 13 14 17 mm **6**

103,40 €

1RM/SH8

8 10 11 12 13 14 17 19 mm **8**

138,20 €

1RM/SH12

8 9 10 11 12 13 14 15 16 17 18 19 mm **12**

103,85 €

1RZ/SH8

5/16" 3/8" 7/16" 1/2" 9/16" 5/8" 11/16" 3/4" **8**

10RM/SH6 Knarren-Ring-Maulschlüssel-Satz, kurze Form

■ ISO 3318 / DIN 3113

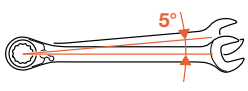

74,10 €



8 10 13 14 17 19 mm



41RM/SH8 Knarren-Ring-Maulschlüssel-Satz, mit Gelenk

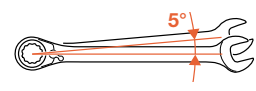

90,30 €



8 10 11 12 13 14 17 19 mm





42RM/S12
Knarren-Ringschlüssel
mit Gelenkkopf im Satz

■ Einstellbar bei 180 und 360°



DYNAMIC-DRIVE™

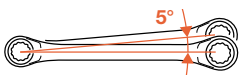

174,15 €

8 9 10 11 12 13 14 15 16 17 18 19 mm
+ 1 Knarrengriff



1320RM/SH8
Knarren-Ringschlüssel-Satz

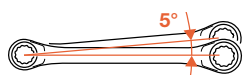

DYNAMIC-DRIVE™



6x7 8x9 10x11 12x13 14x15
16x17 18x19 22x24 mm

99,95 €



S4RM/3T
Vierfach-Knarren-Ringschlüssel-Satz



DYNAMIC-DRIVE™

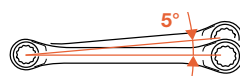

12 GRÖSSEN IN 3 SCHLÜSSELN

8x9x10x11mm
12x13x14x15 mm
16x17x18x19 mm

37,80 €



ROLLGABEL- SCHLÜSSEL

ERGO™ Rollgabelschlüssel



- ISO 6787, DIN 3117, ASME B107.8M-2003 und BS 6333



- Verchromt, präzisionsgehärtet und rostschutzbehandelt

BAHCO	mm	mm	mm	g	€
9029 C	32	5	170	220	25,90
9031 C	38	6	218	340	28,25

ERGO™ Rollgabelschlüssel mit schlanken Backen



- Phosphatiert, präzisionsgehärtet und rostschutzbehandelt

BAHCO	mm	mm	mm	g	€
9029-T	32	4.5	170	196	27,15
9031-T	38	4.5	218	325	32,55

Klassische Rollgabelschlüssel



- ISO 6787, DIN 3117, ASME B107.8M-2003 und BS 6333

- Verchromt, präzisionsgehärtet und rostschutzbehandelt Modelle 8074 + 8075 brüniert

BAHCO	mm	mm	mm	g	€
8069 C IP	13	4	110	60	19,90
8070 C IP	20	4.9	155	132	21,05
8071 C IP	27	6	205	255	22,25
8072 C IP	30	8.6	255	400	28,60
8073 C IP	34	11.9	305	665	41,15
8074 C IP	44	14	380	1035	69,35
8075 C IP	53	17.7	455	1665	108,00
8074	44	14	380	1035	60,90
8075	53	17.7	455	1665	94,00

ADJUST 3 Rollgabelschlüssel-Satz



- Brüniert, präzisionsgehärtet und rostschutzbehandelt

49,00 €



Inhalt	mm	mm
8070	20	155
8071	27	205
8072	30	255

86 Rollgabelschlüssel

- ISO 6787, DIN 3117, BS 6333, ASME B107.8M - 1996



mm	mm	g
63	614	3165

- Phosphatiert, präzisionsgehärtet und rostschutzbehandelt



ADJUST 9031/29
ERGO™ Rollgabelschlüssel-
Satz

■ Brüniert

34,00 €

+40%

Inhalt	mm	mm
9029 C	32	170
9031 C	38	218

PATENT N^o 4066.

BESKRIFNING
OFFENTLIGGJORD AF

1892

Der Rollgabelschlüssel wurde im Jahre 1892 von J. P. Johansson, dem Begründer von Bahco erfunden und patentiert. Seitdem arbeitet Bahco kontinuierlich an Verbesserungen in Design und Ausführung.

SEITENSCHNEIDER

ERGO™ Seitenschneider für Elektriker

■ ISO 5749

ergo®



Ergonomischer Zweikomponentengriff für optimalen Halt



Progressive Schneiden:
Harte Materialien werden nah am Gelenk und weiche Materialien an der Spitze geschnitten



Induktionsgehärtete Schneidkanten

Schraubverbindung gewährleistet exzellente Schneidleistung und Passgenauigkeit

BAHCO	mm	Fe+ mm		€
2101G-125	125	2.2	brüniert	25,95
2101G-140	140	2.5	brüniert	26,15
2101G-160	160	2.7	brüniert	26,80
2101G-180	180	2.7	brüniert	29,40

BAHCO	mm	Fe+ mm		€
2101GC-125IP	125	2.2	verchromt	29,60
2101GC-140IP	140	2.5	verchromt	30,35
2101GC-160IP	160	2.7	verchromt	31,15
2101GC-180IP	180	2.7	verchromt	34,30

21HDG-180

ERGO™ Seitenschneider für Mechaniker

■ ISO 5749

ergo®



Progressive Schneiden



32,95 €

Schlänke Kopfform ermöglicht gute Zugänglichkeit bei geöffneten Backen



mm	Fe+ mm
180	2.7

1520 G

Kraftschneider



63-64 Hrc



26,95 €

Zentrierte präzisionsgeschliffene Schneiden, für Piano-, harte und weiche Drähte

mm	Fe+ mm
208	3.8

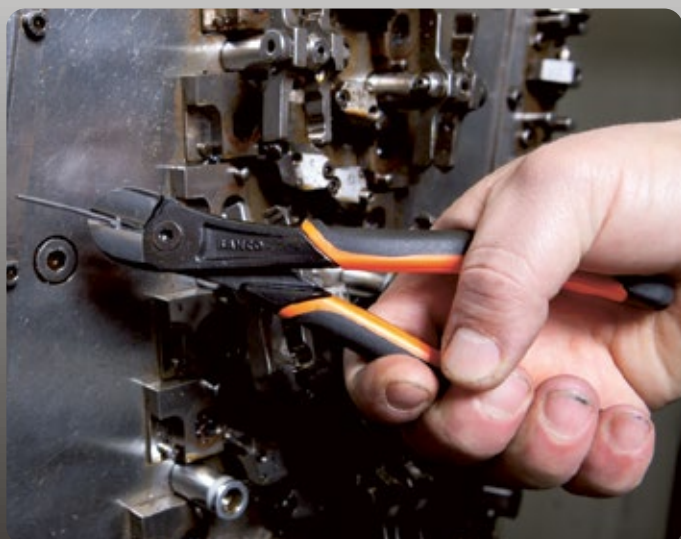

2101PG-160

ERGO™-Seitenschneider

■ ISO 5749

Speziell für Kunststoff

ergo®



mm	CU	PA (Nylon)
160	1.5 mm	3.0 mm

42,70 €

ERGO™ ZANGEN

ERGO™ Kombinationszangen

■ ISO 5746



Ergonomischer
Zweikomponentengriff
für optimalen Halt



Öffnungsfeder
Ein / Aus

Induktionsgehärtete
Schneidkanten

Schlanke, abgerundete
Backen



2628 GC-
verchromt

2628 G
brüniert

BAHCO	mm	mm*		€
2628 GC-160IP	160	2.0	verchromt	27,25
2628 GC-180IP	180	2.5	verchromt	28,80
2628 GC-200IP	200	3.0	verchromt	31,20
2628 G-160	160	2.0	brüniert	23,40
2628 G-180	180	2.5	brüniert	24,80
2628 G-200	200	3.0	brüniert	26,95

*Pianodraht

ERGO™ Flachrundzangen

■ ISO 5745



Schlanke, halbrunde Backen
und gezahnte Greifflächen



2430 GC-
verchromt

2430 G
brüniert

Lange Spitzen für verbesserten Zugriff

BAHCO	mm	CU mm	Fe mm	Fe+ mm	€
2430 GC-160 IP	160	3.0*	1.8*	1.6*	31,70
2430 GC-200 IP	180	3.0*	1.8*	1.6*	37,90
2430 G-160	160	3.0*	1.8*	1.6*	27,25
2430 G-200	180	3.0*	1.8*	1.6*	32,55

ERGO™ Flachrundzangen, gekröpft

■ ISO 5745



2427 GC-
verchromt

2427 G
brüniert

Schlanke, halbrunde Backen
und gezahnte Greifflächen

BAHCO	mm	CU mm	Fe mm	Fe+ mm	€
2427 GC-160IP	160	3.0	1.8	1.6	35,45
2427 GC-200IP	160	3.0	1.8	1.6	42,55
2427 G-200	200	3.0	1.8	1.6	36,50

Wasserpumpenzangen

■ ISO 8976

Komfortabler
Zweikomponentengriff



Schlanke Backen für gute
Zugänglichkeit



25 einstellbare
Positionen

BAHCO	mm	mm	€
7223	49	200	22,25
7224	61	250	22,75
7225	71	300	32,25

ERGO™ Wasserpumpenzangen



■ ISO 8976

Einstellknopf zur
Einhand-Bedienung



Komfortabler
Zweikomponentengriff

11 – 12
einstellbare
Positionen

BAHCO	mm	mm	€
8224CIP	45	250	43,05
8225CIP	55	315	57,10

ERGO™ Rohrzanzen



■ DIN 5234

■ Schmale Backen für
verbesserte Zugänglichkeit

Komfortabler
Zweikomponentengriff



Patentierte progressive Verzahnung
mit induktionsgehärteten Zähnen
für besseren Halt



BAHCO	mm	mm	mm	€
1410	45	1" – 38 mm	320	48,85
1420	65	1 1/2" – 57 mm	430	65,50

SPEZIALZANGEN

9938

Sicherungsringzangen-Satz

■ Für Innen-Sicherungsringe Ø 8 – 100 mm und Außen-Sicherungsringe Ø 3 – 100 mm

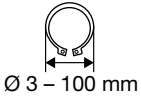
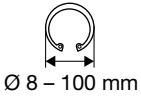

99,95 €

Deckt den Anwendungsbereich von mehr als 10 konventionellen Sicherungsringzangen ab

2928-160



2928-200



2928-250



■ Austauschbare Spitzen (gerade, 15° und 90°) für Innen- oder Außen-Sicherungsringe

Inhalt	mm	mm	mm	
2928-160	160	7-26	3-35	5
2928-200	200	10-51	7-51	5
2928-250	250	46-102	32-102	6

9897

ERGO™ Zangensatz

ergo®



Inhalt	
2101G-160	Seitenschneider
2628G-180	Kombinationszange
2430G-160	Flachrundzange
8224	Wasserpumpenzange

83,40 €

28-29/S4

Sicherungsringzangen-Satz

■ für Innen- und Außen-sicherungsringe

94,50 €



2800-180
gerade Spitze
Ø 19 – 60 mm



2890-180
gebogene Spitze
Ø 19 – 60 mm



2900-180
gerade Spitze
Ø 19 – 60 mm



2990-180
gebogene Spitze
Ø 19 – 60 mm

Kunststoffrohrscheren



PE, PP, PB, PEX, MLP/MSR, VPE, CPVC, PVC, PVDF

- Einfacher, gerader und präziser Schnitt
- Klingenwechsel ohne Werkzeug
- Einhand-Schnellspanner für die Klinge

Edelstahlklinge mit PTFE-Beschichtung



BAHCO	mm	mm	g	€
411-35	35	220	273	38,70
411-42	42	240	435	50,75

2650 Connectorzange



- Mit austauschbaren Nylon-einsätzen und Verbindungen
- Verhindert Beschädigungen an Oberflächen

1 | 2 | 3
Einstellbar in 3 Positionen

mm	max. mm
235	65

24,95 €

2855 Drahtwirbelzange



Backen abgewinkelt und gezahnt, mit Schneide 30°

- Zur Sicherung von kritischen, vibrationsanfälligen Stellen mit Draht, für jede Draht- und Verdrehungslänge verwendbar
- Ermöglicht in Sekundenschnelle exaktes Wirbeln und erspart dadurch beträchtlich Zeit

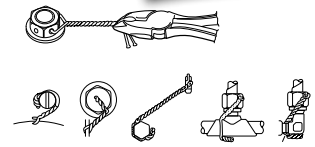

mm	Fe+ mm
235	1.04

104,95 €

Durchlaufscheren

- Klingen geschmiedet aus spezialgehärtetem Werkzeugstahl

Griffe aus Fiberglas und Nylon

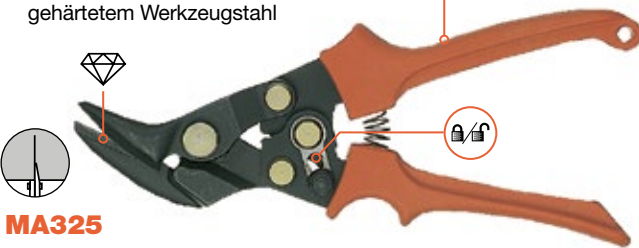

MA325

- Durchlaufschere mit Hebelübersetzung
- Für gerade und durchlaufende Schnitte

Weiche Griffe mit Öffnungsfeder



MA351 / MA361

- Schneiden aus widerstandsfähiger Chrom-Molybdän-Stahllegierung
- Abgewinkelter Schneidkopf für verbesserten Zugang

BAHCO	mm	Schnitt	1 mm	2 mm	€
MA325	250	gerade	0.8	1.2	36,30
MA351	250	links	1.0	1.5	23,00
MA361	260	rechts	1.0	1.5	22,70

Max. Schneidkapazität: 1 = rostfreier Stahl, 2 = kaltgewalzter Stahl

2951-250 Gripzange mit Drahtschneider



Schlanke Backen mit Aussparung

Schneiden zum Trennen von Schweißdrähten etc.

mm	max. mm	Fe+ mm
250	63	3.0

30,35 €

316-2 Stift-Entgrater



- Kunststoffgehäuse mit zusätzlicher HSS-Klinge im Inneren
- Ersatzklinge erhältlich: 316-2-95

19,30 €

DRUCKLUFT- WERKZEUGE

Druckluft-Schlagschrauber

120 mm



BPC813
1/2"
max. 678 Nm

BPC814
1/2"
max. 624 Nm

BPC815
1/2"
max. 1112 Nm

BPC817
3/4"
max. 2034 Nm

BAHCO	■	BAR	mm	l/min	Nm	Max Nm	min ⁻¹	dba	mm	kg	€
BPC813	1/2"	6.3	10	113	407	678	10000	87	120	1.54	179,00
BPC814	1/2"	6.3	10	113	338	624	12000	87	142	1.24	199,00
BPC815	1/2"	6.3	10	113	786	1112	8000	88	187	1.91	219,00
BPC817	3/4"	6.2	10	198	1627	2034	5000	96	220	3.44	473,00

Video Bedienungs- & Wartungsanleitung



BP500 Magnethalter

49,00 €

BP814A Winkelschlagschrauber



1/2"
max. 244 Nm

- Leistungsfähiger und schneller als eine Ratsche
- Zugänglicher als ein Schlagschrauber
- Ideal für den Einsatz auf engstem Raum

■	BAR	mm	Nm	Max Nm	min ⁻¹	dba	mm	kg
1/2"	6.2	10	195	244	7000	97	334	1.8

BP601 Exzentrerschleifer 5 mm

Inklusive Velcro® Schleifscheibe

169,00 €

Anwendbar mit zentralem Vakuumsystem

mm	BAR	mm	l/min	W	min ⁻¹	dba	m/sec ²	mm	kg
152	6.3	10	255	224	11000	80	< 2.50	195	0.8

BP700
Mini-Ratsche
1/4"



BP820
Druckluft-Ratsche
3/8"



BP821
Druckluft-Ratsche
1/2"



BP218
Druckluftpistole



- Erfüllt OSHA Anforderungen
- Messingeinlass

BAR	mm	l/min	dba	mm	kg
6.3	10	158	<80	210	0.15

BP219
Druckluftpistole



- Messingeinlass

BAR	mm	l/min	dba	mm	kg
6.3	10	68	<80	240	0.13

BP822
Stabschleifer 3 mm



mm	BAR	mm	l/min	W	min ⁻¹	dba	m/sec ²	mm	kg
3	6.3	10	170	201	25000	85	4.52	165	0.5

Druckluft-Spiral-schläuche

- Elastischer Polyurethan-Schlauch mit Gewindeanschlüssen an beiden Enden



BAHCO	BAR	mm	mm	m	kg	€
BPH1010B	6.3	1/4-1/4 BSP	10	10	0.86	31,50
BPH1310A	6.3	3/8-3/8 NPT	13	10	1.67	65,00

Druckluftschlauch-Aufroller



- 145° Stahltrommel
- Gehäuse aus korrosionsbeständigem und strapazierfähigem Polypropylen
- Feste Verriegelung zum automatischen Einklinken des Schlauchs in der gewünschten Länge



Öffnungsfeder für Verriegelungssystem

BAHCO	BAR	mm	mm	m	kg	€
BPHRC815	15	1/4-1/4	8	15	5.5	228,00
BPHRC1015	15	3/8-3/8	10	14+1	5.9	249,00

BANDSÄGEN



Präzision kennt keine Kompromisse.

Unser Qualitätsanspruch auch nicht.

BI-METALL-SÄGEBÄNDER

Zahnspitzen aus Hochleistungsschnellstahl kombiniert mit flexiblem Trägermaterial ergeben Sägebänder mit einer hohen Produktivität für die meisten Anwendungen. Die Anforderungen des Marktes nach Mehrzweck-, Kontur-, Rohr-, Profil-, Gießerei und Produktionssägebändern, können wir komplett bedienen. Sandflex® Sägebänder zerspanen unterschiedliche Stahlarten z. B.: Baustähle, Vergütungsstähle, Hochlegierte Stähle, Edelstähle, Titan, Nickel Basis Legierungen, Gusseisen, Messing, Kupfer und Aluminium und weitere Materialien.

HARTMETALL-SÄGEBÄNDER

Hochleistungsträgermaterial mit optimierter Hartmetallbestückung ergibt ein leistungsfähiges Premiumsägebänder. Diese Sägebänder schneiden schneller bei höherer Standzeit, als viele andere Sägebänder. Sie sind für eine Vielzahl verschiedener Anwendungen geeignet. Die Sägebänder sind speziell zum hocheffizienten Sägen schwer zerspanbarer und abrasiver Materialien, sowie zum Hochleistungssägen von großen und schwer zu sägenden Werkstücken entworfen worden.

Für Informationen zu beschichteten Sägebändern sprechen Sie uns bitte an.

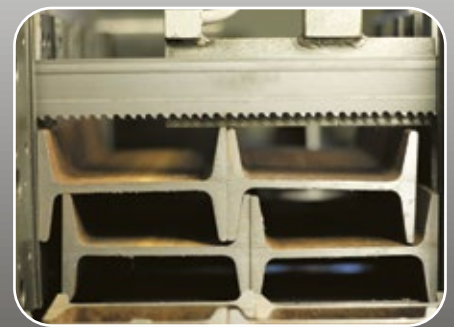

 Video Easy-Cut Sägebänder in der Praxis



 Video Herstellungsprozess der Hartmetallsägebänder



 Download PDF Bandsägen-Katalog



FEILEN

ERGO™ Feilensätze

- In Rolltasche

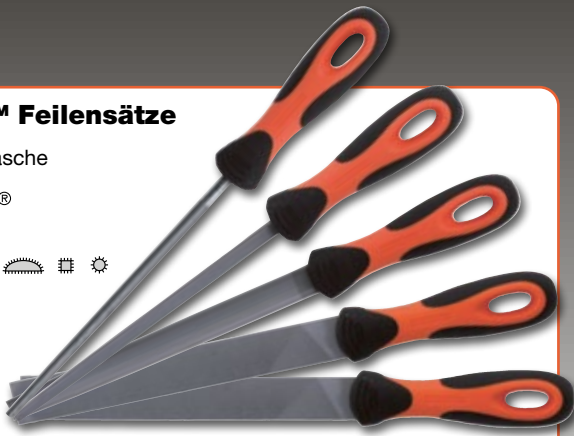

- Das Heft umschließt die Schultern der Feile um Verletzungen zu vermeiden
- Inhalt: Ansatzfeile (Hieb 2*), Ansatz-, Vierkant-, Halbrund- und Rundfeile (Hieb 1*)

BAHCO	Inhalt	€
1-478-08-1-2 200 mm	1-210-08-1-2; 1-230-08-1-2; 1-100-08-1-2; 1-100-08-2-2; 1-160-08-1-2	29,00
1-478-10-1-2 250 mm	1-210-10-1-2; 1-230-10-1-2; 1-100-10-1-2; 1-100-10-2-2; 1-160-10-1-2	39,00

* Hieb 1 = Bastard, Hieb 2 = Halbschlicht



Nadelfeilen-Sätze

- Für feine Feil- und Polierarbeiten



2-470-16-2-0



- Hieb: 2 = Halbschlicht
- Inhalt: je eine Ansatz-, Flach-, Halbrund-, Vierkant-, Quadrat- und Dreikantfeile, ein Kunststoff-Feilenheft

2-472-16-2-0



- Hieb: 2 = Halbschlicht
- Inhalt: je eine Ansatz-, Flach-, Dreikant-, Vierkant-, Halbrund-, Vogelzungen-, Rund-, Messer-, Baret-, Schwert-, Rundkanten- und Halbrundfeile, ein Kunststoff-Feilenheft

ERGO™ Ansatzfeilen



BAHCO	mm	Hieb*	€
1-100-08-1-2	150	1	8,40
1-100-08-2-2	150	2	8,55
1-100-10-1-2	200	1	9,90
1-100-10-2-2	200	2	10,10

ERGO™ Halbrundfeilen



BAHCO	mm	Hieb*	€
1-210-08-1-2	150	1	11,10
1-210-08-2-2	150	2	11,20
1-210-10-1-2	200	1	12,75
1-210-10-2-2	200	2	13,15

* Hieb 1 = Bastard, Hieb 2 = Halbschlicht

ERGO™ Dreikantfeilen



BAHCO	mm	Hieb*	€
1-170-08-1-2	150	1	9,30
1-170-08-2-2	150	2	9,50
1-170-10-1-2	200	1	11,75
1-170-10-2-2	200	2	12,10

ERGO™ Rundfeilen



BAHCO	mm	Hieb*	€
1-230-08-1-2	150	1	8,25
1-230-08-2-2	200	1	8,50
1-230-10-1-2	150	2	9,10
1-230-10-2-2	200	2	9,90

LOCHSÄGEN

3834-SET-72-35/83 Lochsägensatz

- Bimetal mit gehärteten Zähnen aus hochlegiertem Schnellarbeitsstahl
- Für alle bearbeitungsfähigen Werkstoffe wie Holz, Nichteisen- und Eisenstähle einschließlich Edelstahl



	Ø mm	35 40 44 51 57 68 83
Aufnahmeschaft	Ø 32-100 mm	
Zentrierbohrer	Ø 6,35	



59,00 €

NEU

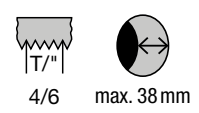

3834-SET-152 Lochsägensatz für Maschinenbau, Sanitär- und Elektroinstallation

- Bimetal mit gehärteten Zähnen aus hochlegiertem Schnellarbeitsstahl
- Für alle bearbeitungsfähigen Werkstoffe wie Holz, Nichteisen- und Eisenstähle einschließlich Edelstahl



	Ø mm	16 19 22 25 32 35 44 51 57 60 65 68 73 76 83
Aufnahmeschäfte	Ø 14-30 mm & Ø 32-210 mm	
Zentrierbohrer	Ø 6,35	



119,00 €

NEU

3834-upsize Adapter zum Vergrößern von (Bohr-) Löchern

- Mit Hilfe des Adapters kann eine kleinere Lochsäge zur Führung bei bestehenden Bohrlöchern aufgesetzt werden



≥ 32 mm < 32 mm

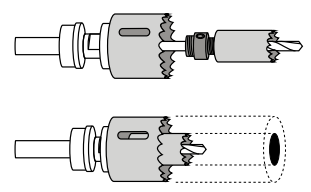

2,20 €

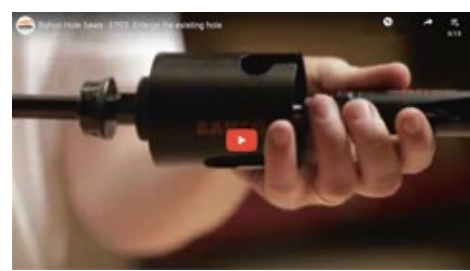

Praxisvideo

<https://youtu.be/F9wCwN0Wfvg>

METALLSÄGEN

319 Metallsägebogen



- Leichter Rahmen mit Stahlkern

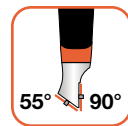

Spannmechanismus im Griff

Sandflex® Bimetall
 <mm> 300 T^m 24

19,00 €



208 Minisägebogen 250 mm



10,75 €

Sandflex® Bimetall
 <mm> 250 T^m 24



321 Metallstichsäge

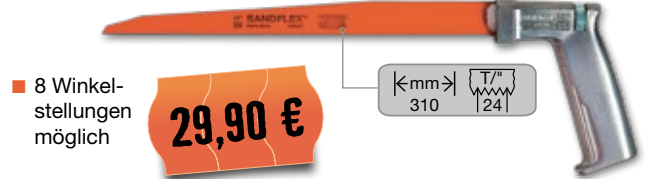

- 8 Winkelstellungen möglich

29,90 €

<mm> 310 T^m 24

320 Metallsägebogen



8,95 €

- Rahmenhöhe 110 mm
- Alternative Blattspannung bei 90°

110 mm

Sandflex® Bimetall
 <mm> 300 T^m 24

268 Juniorsäge

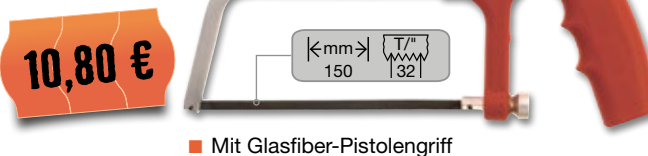

10,80 €

- Mit Glasfaser-Pistolengriff

<mm> 150 T^m 32

Sägeblätter für Juniorsäge 268

- Für Metall und Kunststoffe

10

BAHCO			<mm>	€
228-32-10P	10	32	150	4,20

3906 SANDFLEX® Bimetall Sägeblätter



- Splitterfreies, flexibles Bimetall-Blatt
- 20 % schnellere Schnittleistung, 35 % längere Lebensdauer

BAHCO			<mm>	€
3906-300-18-10P	10	18	300 x 13 x 0,65	9,50
3906-300-24-10P	10	24	300 x 13 x 0,65	9,50
3906-300-32-10P	10	32	300 x 13 x 0,65	9,50
3906-300-3P	3	18 / 24 / 32	300 x 13 x 0,65	6,50
3906-300-18-100	100	18	300 x 13 x 0,65	1,40*
3906-300-24-100	100	24	300 x 13 x 0,65	1,40*

* Preis pro Stück

WERKZEUG-KOFFER

Hartschalenkoffer

- Deckel durch 2 Metallbügel gesichert
- Dokumentenfach



Zentrales Verschlusssystem mit einem Schlüssel



Bodenfach mit herausnehmbaren Trennwänden

Gummierter, weicher Tragegriff

Serie 4750RC



↑
↓

Robuster Teleskopgriff aus Aluminium

Serie 4750RCW



Ø 60 x 20 mm



450 x 410 x 210 mm



4750RC02 Hartschalenkoffer

- Werkzeugtafel im Deckel mit Kunststofftaschen auf zwei Seiten
- Werkzeugtafel am Boden mit Kunststofftaschen auf einer Seite

199,00 €



465 x 410 x 255 mm



4750RCW01 Hartschalenkoffer mit Rollen

- Werkzeugtafel im Deckel mit Kunststofftaschen auf zwei Seiten
- Werkzeugtafel am Boden mit Kunststofftaschen auf einer Seite
- Mit Teleskopgriff und Rollen

325,00 €



465 x 405 x 255 mm



4750RCW011 Hartschalenkoffer mit Rollen

- Werkzeugtafel im Deckel mit Gummistreifen auf zwei Seiten
- Werkzeugtafel am Boden mit Gummistreifen auf einer Seite
- Mit Teleskopgriff und Rollen

349,00 €

4750PTB60

Tragbare Werkzeugbox, leer

- Extrem robust, auch unter härtesten Bedingungen

41,35 €

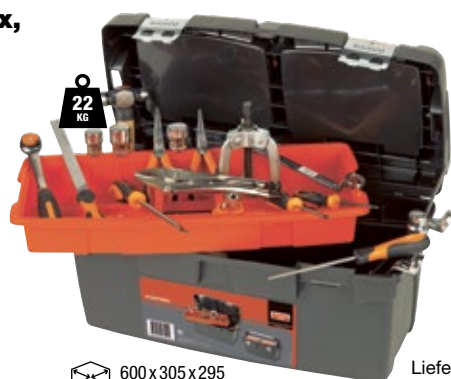

600 x 305 x 295 mm

Lieferung ohne Werkzeuge

Aluminium-Griff

Zwei separate Boxen außen



Stabile Hartschalenkoffer aus Polypropylen

- Resistent gegen Korrosion, Schmutz, Wasser und Skydrol
- Steckstifte aus Edelstahl
- Verschließbar mit einem Vorhängeschloss

Gummibeschichteter Tragegriff

2 Schnappverschlüsse

430 x 340 x 156 mm

Luftdichter Polyurethan Dichtungsring

220,15 €

Kennzeichnungsetikett
Ventil zum Luftdruckausgleich

4750RCHD01 Hartschalenkoffer

- Mit gepolstertem Schultergurt

Verstärkungen in stark beanspruchten Bereichen

545 x 350 x 240 mm

4750RCHDW01 Hartschalenkoffer mit Rollen

- Mit Rollen und Teleskopgriff
- Räder: Ø 60 x 20 mm

280,00 €

-33°C – +90°C

630 x 480 x 290 mm

4750RCHDW02 Großer Hartschalenkoffer mit Rollen

- Mit Rollen und Teleskopgriff
- Räder: Ø 60 x 37 mm

399,00 €

4750RCHDW01FF3

Hartschalenkoffer auf Rädern mit Teleskopgriff inklusive 5 bestückter Werkzeugeinlagen

1/4" + 3/8"

- Für allgemeine Wartungsarbeiten
- Metrisch
- Einlagen: FF2B12, FF2B13, FF2B14, FF2B15, FF2B16

194



1.799,00 €



Download PDF Produktblatt



WERKZEUGTASCHEN

4750FB1-19B
19" Werkzeugtasche mit Abdeckung, leer

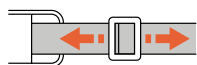

49,50 €



Lieferung ohne Werkzeuge

- Mit verstärktem Kunststoffboden
- Gepolsterter Tragegurt und Griff

470 x 230 x 355 mm

4750FB1-19A
19" Offene Werkzeugtasche mit Kunststoffboden, leer

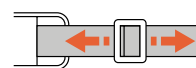

39,50 €



Lieferung ohne Werkzeuge

- Wasserdichter Kunststoffboden

470 x 230 x 355 mm

4750-VDEC
Elektrikertasche aus Leder, leer

154,30 €



- Aluminium verstärkter Rahmen
- Innenliegende Aluminiumplatte

290 x 190 x 445 mm

3100TB
Offene Werkzeugtasche, leer

34,95 €



- Wasserfester Boden
- Bequemer gepolsterter Tragegurt und Griff

400 x 600 x 400 mm

4750FB3-12
12" Elektriker
Werkzeugtasche, leer



Lieferung ohne
Werkzeuge

Bodentasche
inkl. Plastikbox

57,80 €

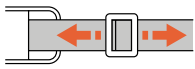

■ Mit verstärktem
Kunststoffboden

285 x 285 x 190
mm



4750FB4-18
Werkzeug und
Laptoptasche, leer

- Gepolstertes
Laptop-Fach
- Mit verstärktem
Kunststoffboden

86,60 €



Lieferung
ohne
Werkzeuge



350 x 430 x 150
mm

4750-VMPH-1
Handytasche

- Befestigung durch Klett-
verschluss passend für alle
Gürtel



11,85 €



Werkzeug Organizer, leer

Lieferung
ohne
Werkzeuge



8,45 €

4750FB5A
Klein

275 x 170 x 55
mm

Lieferung
ohne
Werkzeuge

14,15 €

4750FB5B
Mittel

- Weicher Gummigriff

330 x 270 x 70
mm

Lieferung
ohne
Werkzeuge

18,05 €

4750FB5C
Groß

- Weicher Gummigriff
- Netzfach für Dokumente

400 x 300 x 90
mm

AUTOMOTIVE

BBCE12-10

Vollautomatisches mikroprozessorgesteuertes Batterielade- und Batterieerhaltungsgerät
10 Ampere, 8-stufig

12V 6-130 Ah
 AGM, PB, GEL, SLI, VRLA, EFB, LiFe

230 V AC
 12V DC @10A IP20
 mikroprozessorgesteuert



1,4 kg
 CE

79,95 €



BH13000

Wagenheber, 3 Tonnen

■ Doppelkolben ermöglicht bis 50 % schnelleres Anheben



249,00 €

Video Bedienungs- & Wartungsanleitung

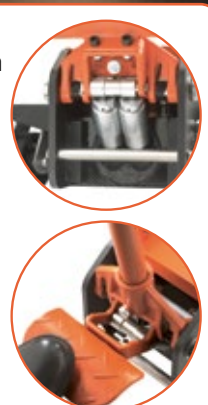

CONNECT & FORGET

Der 8-stufige Ladezyklus macht das Laden nicht nur effizienter, sondern stellt auch einen korrekten Ladevorgang sicher und sorgt so für eine verlängerte Lebensdauer Ihrer Batterie.

1. Analyse
2. Wiederherstellen
3. Softstart
4. Bulk-Modus
5. Absorption
6. Überwachung
7. Float-Modus
8. Erhaltungsladung

BH4S-

Flaschenwagenheber

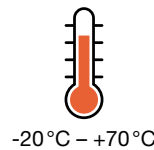

BAHCO	T	mm	mm	kg	€
BH4S2	2	181	345	2,2	22,20
BH4S4	4	194	372	3,4	24,95
BH4S6	6	216	413	5,0	32,95
BH4S8	8	230	457	5,7	39,95
BH4S12	12	230	465	7,8	49,95
BH4S20	20	242	452	13,0	82,95

BH5SP500QA

Hydraulischer Getriebeheber

- Zur De-/Montage von Getrieben unter Hebebühnen
- Schneller Einsatz dank zwei Schnellpumpen (mit 38 Pumpstößen auf voller Höhe)
- Hohe Stabilität durch breites Fahrgestell
- Absenkung durch Federmechanismus



199,00 €

BH5DP1000QA

Hydraulischer Getriebeheber

- Zur De-/Montage von Getrieben unter Hebebühnen
- Schneller Einsatz dank zwei Schnellpumpen (mit 36 Pumpstößen auf voller Höhe)
- Anheben der Last über Fußpumpe, dadurch freie Hände



499,00 €

LAMPEN / INSPEKTION

5050 Stethoskop **61,15 €**



- Mit Stahlsonde

5515M Reparaturspiegel **22,75 €**



Ø 30 mm
210 mm

5515T-52 Teleskop-Gelenkspiegel **10,80 €**



Ø 50 mm
255 - 450 mm

BLTS10 Taschenlampe mit Fokus **39,60 €**



262 mm

- 10 SMD LED
- 180 Lumen
- 4 h
- IP20
- USB
- 2100 mAh-s Li-ion

BLTS7P Taschen- und Stablampe **35,95 €**



170 mm

- 7 SMD LED
- 45 Lumen
- 4 h
- IP20
- USB

BFRL11 Stirnleuchte **43,50 €**



1,6 m
1 m

- 2 digitale Lichtmodi: geringer Lichtstrom (20%), hoher Lichtstrom (100%)
- Optische Linse
- 260 Lumen



BLTFS6U Flexible Leuchte mit UV-Licht **78,15 €**



- Fungiert als herkömmliche Lampe, Inspektionsleuchte sowie Taschenlampe in einem
- Ladestandsanzeige

3 h IP20 1200 mAh-s Li-ion

4 SMD LED 250 Lumen 80 Lumen 6 UV LED

BLTFC1 Flexible Stablampe mit Aluminiumrahmen **59,95 €**



- Ladestandsanzeige

360°

1 SMD LED 180 Lumen 2.5 h

IP20 2000 mAh-s Li-ion

USB

BLTS6I Taschenlampe mit Induktionsladung **111,70 €**

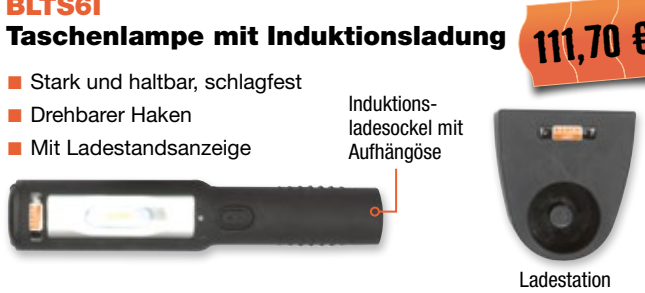

- Stark und haltbar, schlagfest
- Drehbarer Haken
- Mit Ladestandsanzeige

Induktionsladesockel mit Aufhängöse

Ladestation

6 SMD LED 200 Lumen 3 h IP60 2100 mAh-s Li-ion



SNA Europe [Deutschland]

Ein Geschäftsbereich der SNA Germany GmbH
Willettstraße 10 · 40822 Mettmann
Tel.: +49 2104 833 83-0
info.de@snaeurope.com



SNA Europe

SNA Germany GmbH
Zweigniederlassung Österreich
Tel.: +49 2104 833 83-0
info.at@snaeurope.com



SNA Europe

SNA Germany GmbH
Verkaufsbüro Schweiz
Tel.: +49 2104 833 83-0
info.ch@snaeurope.com



www.bahco.com



Klimaneutral

Druckprodukt

ClimatePartner.com/53115-1812-1001

SNA Europe

DE/AT/CH akut 190812. Printed in Germany.
Papier: Tauro Offset, PEFC zertifiziert